

## LAMP BASES



BA15d  
IEC 7004-11  
DIN 49721  
DL  
Bayonet



BA15s  
IEC 7004-11A  
DIN 49720  
SC  
Bayonet



BA20d  
IEC 7004-12  
DIN 49730



E10  
IEC 7004-22  
DIN 49610  
miniature  
Edison



E14  
IEC 7004-23  
DIN 49615  
small  
Edison



E27/E26  
IEC 7004-21  
DIN 49620  
E26-NA  
E27-EURO



E40/E39  
IEC 7004-21  
DIN 49625  
E39-NA  
E40-EURO



FaX1.5-3x1



G4  
IEC 7004-72  
DIN 49757  
2-pin



GX5.3  
IEC 7004-61  
DIN 49640  
2-pin

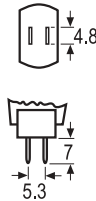

G5.3-4.8  
2-pin



GY5.3  
2-pin



G6.35-15  
G6.35-20  
G6.35-25  
IEC 7004-59  
2-pin



GX6.35-25  
IEC 7004-59  
2-pin



GY6.35-15  
IEC 7004-59  
2-pin



GZ6.35  
IEC 7004-59 A  
DIN 49754  
2-pin



GZX9.5  
GZZ9.5  
IEC 7004-70 B  
DIN 49756  
2-pin  
pre-focus



G9.5  
IEC 7004-70  
medium  
2-pin

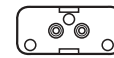

GX9.5  
DIN 49638  
IEC 7004-70 A  
2-pin  
pre-focus



GY9.5  
GZ9.5  
DIN 49756  
IEC 7004-70 B  
2-pin  
pre-focus



GY6.35-15  
IEC 7004-59  
2-pin



GZ6.35  
IEC 7004-59 A  
DIN 49754  
2-pin



GZX9.5  
GZZ9.5  
IEC 7004-70 B  
DIN 49756  
2-pin  
pre-focus



G9.5  
IEC 7004-70  
medium  
2-pin

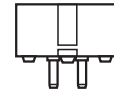

GX9.5  
DIN 49638  
IEC 7004-70 A  
2-pin  
pre-focus



GY9.5  
GZ9.5  
DIN 49756  
IEC 7004-70 B  
2-pin  
pre-focus

## LAMP BASES

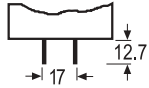

GX16d  
2-pin

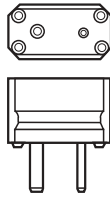

GY16  
DIN 49758  
IEC 7004-45  
2-pin

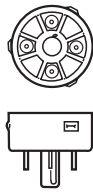

GY17q  
DIN 49758  
IEC 7004-74  
4-pin



GY17t  
DIN 49665  
IEC 7004-45  
4-pin



G22  
IEC 7004-75  
medium  
Bipost



GY22  
2-pin



G38  
IEC 7004-76  
MOGUL  
Bipost



GX38q

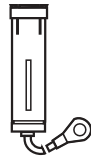

K24s  
Length of cable  
250 mm  
Hole of cable lug  
ø 8.4 mm  
DIN 49748

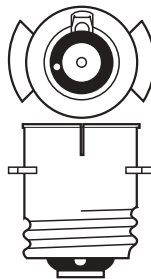

P40s  
DIN 49728  
IEC 7004-43  
medium  
pre-focus



Pico9  
DIN 41539



PG22-6.35  
DIN 49751  
IEC 7004-48

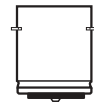

P28s  
DIN 49728  
IEC 7004-42  
MOGUL  
pre-focus

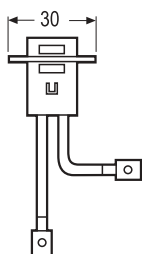

PK30d



R7s  
RX7s  
DIN 49750  
IEC 7004-92

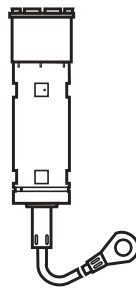

K30s  
Length of cable  
275 mm  
Hole of cable lug  
dia 8.4 mm  
DIN 49748

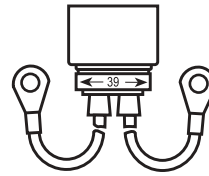

K39d  
with flexible Sialf cable  
Length of cable 300 mm.  
Hole of cable lug dia. 8.4 mm

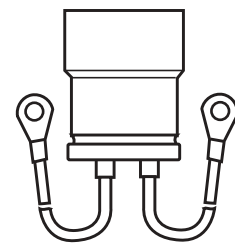

K59d  
with flexible Sialf cable  
Length of cable 350 mm.  
Hole of cable lug dia. 8.4 mm  
DIN 49732

## LAMP BASES

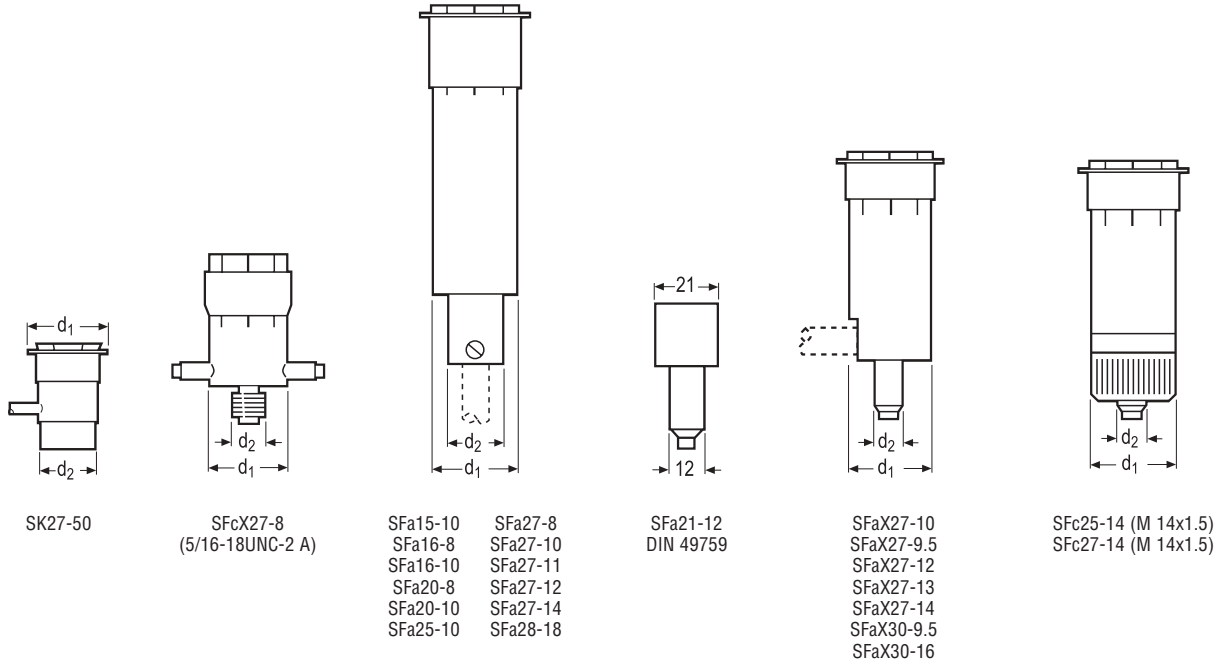

SK27-50

SFcX27-8  
(5/16-18UNC-2 A)

SFa15-10 SFa27-8  
SFa16-8 SFa27-10  
SFa16-10 SFa27-11  
SFa20-8 SFa27-12  
SFa20-10 SFa27-14  
SFa25-10 SFa28-18

SFa21-12  
DIN 49759

SFaX27-10  
SFaX27-9.5  
SFaX27-12  
SFaX27-13  
SFaX27-14  
SFaX30-9.5  
SFaX30-16

SFc25-14 (M 14x1.5)  
SFc27-14 (M 14x1.5)

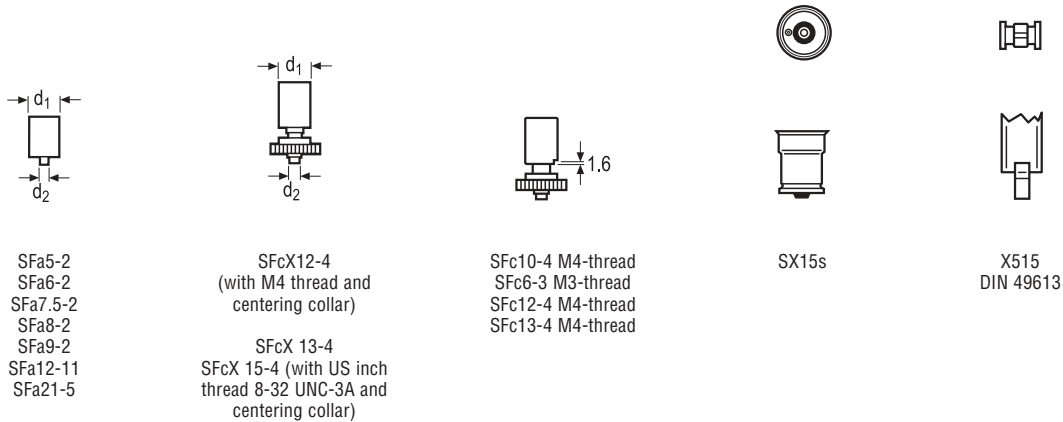

SFa5-2  
SFa6-2  
SFa7.5-2  
SFa8-2  
SFa9-2  
SFa12-11  
SFa21-5

SFcX12-4  
(with M4 thread and  
centering collar)  
  
SFcX 13-4  
SFcX 15-4 (with US inch  
thread 8-32 UNC-3A and  
centering collar)

SFc10-4 M4-thread  
SFc6-3 M3-thread  
SFc12-4 M4-thread  
SFc13-4 M4-thread

SX15s

X515  
DIN 49613