

Cathodeon

HOLLOW CATHODE LAMPS



CONTENTS

- 1 **Hollow cathode lamps**
- 5 **See through hollow cathode lamps**
- 6 **Single element lamps**
- 15 **Multi element lamps**
- 22 **Getting the best from your hollow cathode lamps**
- 24 **Hollow cathode lamps supply**
- 25 **Periodic table**

hi-Tech lamps

800-229-6509

info@hi-techlamps.com

CATHODEON HOLLOW CATHODE DISCHARGE LAMPS

Cathodeon Ltd with over 60 years' experience in vacuum/gas electronic devices is the worlds leading specialist in spectral source technology. Now Europe's undisputed leader in the manufacture of hollow cathode lamps having been at the heart of their design and development since the early years of atomic absorption analysis in the 1960's.

Cathodeon hollow cathode lamps are fitted as original equipment by many of the worlds foremost atomic absorption instrument manufacturers, and as replacements by discerning users the world over.

The Cathodeon hollow cathode lamp programme includes 70 single element and the widest range of proven multi element combinations in standard 1 1/2" (37mm), and 2" (50mm) diameters designed to fit directly into Perkin Elmer AA equipment. Where appropriate these lamps are available with data coded bases permitting the instrument to automatically identify the lamp element. In addition a range of lamps specifically designed for use with Smith Hieftje background correction systems is available.

GENERAL CONSTRUCTION

Hollow cathode lamps consist of a cathode made from the element of interest, an anode and an inert filler gas contained in a glass envelope. In addition various mica discs, ceramic sheaths and glass shields assist in alignment and insulation. The 37mm version is normally fitted with a 2 pin octal base while the 50mm version has a flying lead terminated with a standard M9 plug. Data coded versions of these lamps use multiple pinned octal bases specific to the intended manufacturer whilst the coded plug terminating 50mm lamps mates with the M12 socket in the instrument.

Window

Fig 1 General construction

Mica
Anode
Cathode
Ceramics

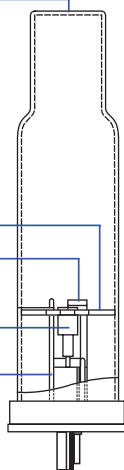

INTERNAL CONSTRUCTION

The base is pressed from the same glass as the body of the bulb to ensure a good stress free seal and the lead through pins made from an alloy with the same co-efficient of expansion as the glass. This minimises the chances of cracking around the pins.

The internal structure is mounted on the base with accurate and consistent positioning of the anode and cathode controlled by precision ceramic insulators on the anode pins. Mica disc insulators have a dual purpose of holding the structure centrally within the lamp envelope and supporting the glass shield which insulates the cathode from other parts of the lamp.



Fig 2
Internal construction
and piece parts

These components combined create a mechanically consistent and robust lamp with the beam of light focused through the centre of the window and free from spurious discharge problems.

THE CATHODE

The cathode is manufactured from either the pure element or the element alloyed with another suitable element. Alloying is used where the element is not available in an appropriate form such as sodium, arsenic etc., to achieve a balanced output (Cd, Cr) or in the case of precious elements, significant cost savings can be made without compromising analytical performance. The alloying elements are carefully chosen not to interfere spectrally with the element of interest. All materials are chosen from the highest purity available, usually 99.99% or better, and in a form from which a cathode can be manufactured that will combine high spectral line intensity, stability, and low noise with good analytical sensitivity. Partially finished cathodes, prepared alloys and raw materials are stored under vacuum where there is a likelihood of deterioration or in air tight containers to avoid contamination and so maintain the highest levels of purity. The elements are then pressed into a cathode cup usually manufactured from steel.

Other cup materials such as nickel, aluminium and brass may be selected to ensure that the cathode operates at an optimal temperature for analytical performance with long life yet remaining free from spectral interference to the cathode element.



Fig 3
Cathodes including
vacuum stored

HOLLOW CATHODE LAMPS

APPLICATIONS

Hollow cathode lamps are gas discharge devices in which the discharge is highly constrained around the cathode of a specific metal. The resultant output is a unique line spectrum, the most intense of which are suitable for highly specific and sensitive metals analysis. Further derivatives of the fundamental technology extend the applications to include:-

- Atomic Absorption Spectrophotometry
- Atomic Fluorescence Spectroscopy
- Multi wavelength laser tuning
- Laser output stabilisation
- Multi component analysers
- Environmental analysers
- Medical analysers

HOLLOW CATHODE LAMPS

THE ANODE

A ring anode is fitted to all Cathodeon lamps, this design being preferred over flag anodes as the ring anode will centralise the discharge for best optical performance, whilst minimising cathode material movement which can cause discharge faults such as flashing.

Fig 4 Anodes and position in structure



The anode is coated with a getter material which assists in removing any impurities released from the cathode during the sputtering process from normal operation. The getter is also activated during lamp processing to collect any impurities remaining in the cathode material. This process deposits the impurities onto the glass bulb in such a form that they remain inert throughout the life of the lamp. It is this process that creates the dark coloured ring on the wall of the envelope adjacent to the getter. This discolouration is perfectly normal and not only will it not affect the operation of the lamp, but for those elements where gettering is critical indicates a well processed lamp of exceptional purity.

ENVELOPE AND WINDOWS

The envelope is constructed from a special borosilicate glass chosen to achieve a good seal between the envelope and the pin base. Cathodeon lamps feature a direct fused-on window construction, essential for exceptional lifetimes, and purity of spectral output. The window material is selected to achieve the optimum transmission of the key spectral lines of the cathode element. Normal practise is to utilise borosilicate glass for wavelengths over 400nm, special UV transparent glass for wavelengths between 240 to 400nm, and high quality quartz for shorter wavelengths.

Fig 5 Transmission of windows

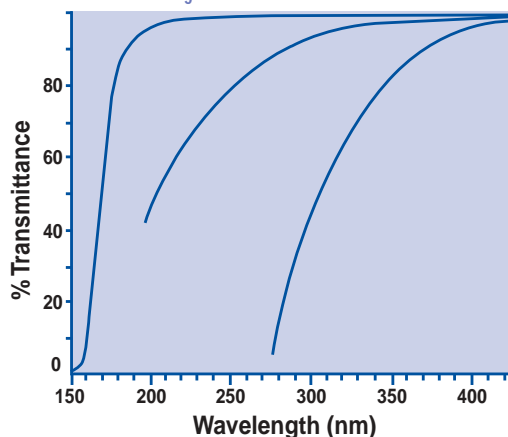

APPLICATIONS

Lamps are filled with an inert monatomic gas of high purity chosen to ensure that the spectral output of the cathode is free from interference.

Both the UV glass and borosilicate windows can be fused directly to the envelope, but quartz windows are attached through a graded seal in which small rings of different glasses of subtly different expansion coefficients are sealed to the envelope in a sequence that absorbs the large expansion differences between quartz and the envelope. All glass parts are fabricated in house to ensure exceptional product performance and reproducibility.

FILL GAS

Hollow cathode lamps are filled with an inert monatomic gas of high purity chosen to ensure that the spectral output of the cathode is free from interference. Neon is the preferred gas for its ease of processing and clean stable outputs. Argon is used for those elements where interference from neon lines is possible, in addition Cathodeon has experience of processing in special gas fills such as krypton and xenon. However users should always be aware of possible spectral interference where non standard gases have been requested.

Fig 6 Reduction of interference

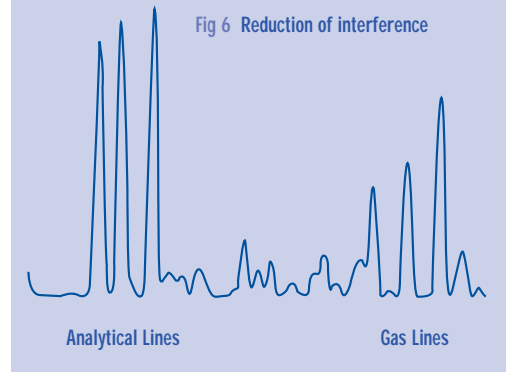

PROCESSING AND TESTING

Lamp manufacturing comprises of 7 stages, cathode manufacture, assembly, sealing, vacuum processing, ageing, testing and final finishing. The cathode is assembled onto the base pins using the micas and ceramics to achieve a reproducibly positioned insulated assembly. The structure is then carefully sealed to the base using techniques that minimise extraneous contamination and do not damage the integrity of the cathode. Once sealed the lamp is attached to the vacuum processing equipment via a pump stem and is subjected to a 16 hour programme of evacuation, baking and cathode processing prior to a final fill with gas.

Fig 7 Age and test area



HOLLOW CATHODE LAMPS

APPLICATIONS

Multi element hollow cathode lamps are particularly useful when carrying out routine analysis on a number of different elements in the same sample where there is sufficient concentration of each element to allow easy detection.

Multi Element Lamps

Cathodeon manufactures the largest range of multi element lamps offering only those combinations which provide sufficient energy and an acceptable lifetime for each element, with no spectral interference. Multi element hollow cathode lamps are particularly useful when carrying out routine analysis on a number of different elements in the same sample where there is sufficient concentration of each element to allow easy detection. Multi element lamps are inevitably a compromise in which energy levels will be lower than single element lamps and hence noise levels may be higher. This may limit ultimate detection levels, single element lamps being preferred wherever sensitivity is an issue.

Boosted Discharge Lamps

Whilst the performance of conventional Cathodeon hollow cathode lamps operating in the deep ultra violet has been considerably enhanced in the past few years, boosted lamps may prove useful in those areas of the deep ultra violet where the output and noise levels from conventional lamps may limit ultra high sensitivity analysis. The increase in output of boosted lamps may reduce noise levels and make possible improved detection limits especially with the high absorption optics typical of Zeeman background correction instruments. The increased output comes about from a secondary cathode emitting an additional source of electrons which excite a greater proportion of the sputtered atoms from the discharge resulting in an enhanced output. The normal operation of the lamp is through the power supply of the host instrument but with the addition of an external power supply for the secondary cathode operating in sequence.

Hollow Cathode Lamps for Special Applications

Cathodeon will be pleased to quote for special hollow cathode lamps. Any combination of element and filler gas can be accommodated whilst window material can also include magnesium fluoride which extends transmission down to 114nm. However, no warranty can be assumed or implied when using such special hollow cathode lamps.

Electrodeless Discharge lamps

The analytical advantages of electrodeless discharge lamps used in the early days of atomic absorption spectrophotometry have today been matched or improved upon by the most recent developments in conventional hollow cathode lamp technology or by boosted discharge lamps. Cathodeon therefore feels unable to offer electrodeless discharge systems due to their low demand, limited range and high cost.

See Through Hollow Cathode Lamps

Cathodeon also manufacture opto-galvanic (see through) hollow cathode lamps, designed to act as a frequency stable reference for high intensity tuneable monochromatic light sources, particularly lasers. Further details are given on page 6.

BACKGROUND CORRECTION LAMPS

Hollow cathode lamps filled with deuterium gas are used by some manufacturers as background correction devices in atomic absorption analysis. Standard size 37mm lamps filled with deuterium gas can be used in all instruments that will take such a lamp, with the exception of some early Varian models for which a specific version is available. Many instruments however, use a deuterium arc lamp for continuous background correction, details of those available are listed in the following table:

MANUFACTURER	MODEL	PART NO.
GBC	All models	J07
Perkin Elmer	2280, 2380, 4000, 5000,	
	272, 280, 360, 372, 373,	
	380, 460	R06
	410, 420, 429, 430	G20
Unicam	SP192	D01
Varian	AA275, AA775, AA875,	
	AA975, AA1275, AA1475,	
	SpectrAA 10	R17
	SpectrAA 20, SpectrAA 30,	
	SpectrAA 40	R17

POWER SUPPLIES

A modulated power supply type C610 is available in both boxed and OEM versions and is designed specifically to drive hollow cathode lamps. Due to the specialist nature of this product the supply is not tested to European EMC regulations and will therefore not carry a CE mark. The OEM version is available and is not subject to these regulations. For more information see page 24.

WARRANTY

All Cathodeon hollow cathode lamps are manufactured to the highest standards and are warranted free from electrical and mechanical defect caused either by workmanship or materials. The lamps provide satisfactory service when used within the limits of our written specification and when used in equipment of standard manufacture. 37mm and 50mm standard and data coded lamps are warranted to emit spectra for a period of 24 months from the date of despatch or 5000 milliampere hours usage, whichever occurs first. The milliampere usage is calculated by multiplying the hours of lamp operation by the lamp operating current. Lamps for use with the self reversal (Smith Hieftje) background correction technique are warranted in hours, which is due to the differing operating techniques of the various manufacturers. The warranty period is different from conventional lamps and from element to element and is listed below:

All lamps 500 hours with the exception of:

As, La, Sb, Se and Ti – 150 hours

Bi, Cs, Na, Si and Ti – 200 hours

Te and K – 300 hours

Deuterium arc background correction lamps are warranted for a period of twelve months or to 50% of original energy.

Should any failure occur within the warranty period the lamp will be replaced free of charge providing that the lamp in question is returned, carriage paid, in its original packing with the completed warranty card and that following testing in the factory it is agreed that the lamp is faulty.

The lamp will only be replaced if the company is satisfied that the lamp has been operated at the recommended currents, and that it has not failed due to accidental damage or misuse by the operator. If a replacement lamp is supplied, the validity of the guarantee shall date from the shipment of the first lamp.

hi-Tech lamps

800-229-6509

info@hi-techlamps.com

Fig 9 See Through Hollow Cathode Lamp Dimensions

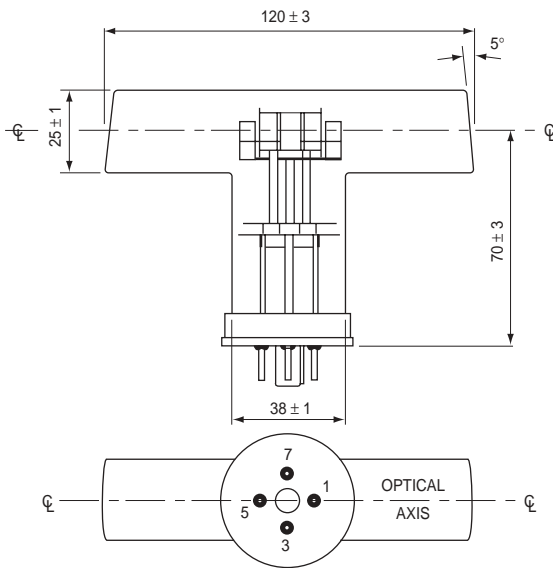

The Cathodeon opto-galvanic (see through) hollow cathode lamp is designed to act as a frequency stable reference for high intensity tuneable monochromatic light sources, particularly lasers. The optically clear path through the cathode enables the source beam to create a resonant excitation with one of the characteristic lines of the hollow cathode lamp's own discharge. The resulting small change in the electrical loading on the lamp supply may be correlated with the amplitude of the source, usually by optically chopping the source at a low frequency.

SPECIFICATIONS

Windows

High purity fused quartz (Spectral range 200 - 5000nm).

Cathode

Most of the cathode materials used in standard Cathodeon hollow cathode lamps may be used in the "see through" design. (Unavailable elements are Rb, Cs, K).

Cathode length is 19mm and bore diameter is in the range 3 to 6mm. Where material is not critical Iron is recommended for its high intensity operation.

Fill Gas

The lamp can be filled with any of the following gases:-

Neon, Argon, Xenon, Krypton, Helium, Deuterium, Hydrogen.

Gas mixtures and other gases may be specified provided they are non-corrosive and non-radioactive. Where the gas is not critical Neon or Argon are recommended based on Cathodeon standard hollow cathode lamp practice. Fill pressure must normally be in the range of 8 to 15mbar.

ELECTRICAL

Striking volts 350—400V

Running volts 200—320V

Maximum continuous current 5 - 20mA

(Each cathode material has a maximum value within this range beyond which life and/or performance is reduced).

Octal base connection

PIN 1 and 5 cathode

(internally connected)

PIN 3 and 7 anodes

(not internally connected)

WARRANTY

These lamps are warranted for 2 years or 1000 hours operation within the recommended current range except where the gas or pressure needed is different from that used in standard hollow cathode lamps, when the warranty is limited to manufacturing defects only.

SEE THROUGH HOLLOW CATHODE LAMPS

APPLICATIONS

The opto-galvanic hollow cathode lamp is designed to act as a frequency stable reference for high intensity tuneable monochromatic light sources, particularly lasers.

hi-Tech lamps

800-229-6509

info@hi-techlamps.com

SINGLE ELEMENT LAMPS

	PART NO.	TYPE	GAS	WINDOW	MAX CURRENT	REC CURRENT	W/LENGTH PRINCIPAL	W/LENGTH ALTERNATE	SENSITIVITY REDUCTION	PERKIN ELMER LEADOUT
ALUMINIUM Al	3UNX/AI	37mm Standard	Ne	UV Glass	10	8	309.3	394.4	2.0 x	C
	3UNX/AI-V	37mm Varian Coded	Ne	UV Glass				396.2	1.2 x	
	3UNX/AI-U	37mm Unicam Coded	Ne	UV Glass				308.2	1.5 x	
	3UNX/AI-SH	37mm Self Reversal	Ne	UV Glass						
	5UN/AI	50mm Standard	Ne	UV Glass	30	25	309.3			
	5UN/AI-P	50mm Perkin Elmer Coded	Ne	UV Glass						
ANTIMONY Sb	3QNY/Sb	37mm Standard	Ne	Quartz	15	12	217.6	231.1	2.0 x	D
	3QNY/Sb-V	37mm Varian Coded	Ne	Quartz				206.8	1.5 x	
	3QNY/Sb-U	37mm Unicam Coded	Ne	Quartz						
	3QNY/Sb-SH	37mm Self Reversal	Ne	Quartz						
	5QN/Sb	50mm Standard	Ne	Quartz	25	20	217.6			
	5QN/Sb-P	50mm Perkin Elmer Coded	Ne	Quartz						
ARSENIC As	3QNY/As	37mm Standard	Ne	Quartz	12	10	193.7	197.2	2.0 x	C
	3QNY/As-V	37mm Varian Coded	Ne	Quartz						
	3QNY/As-U	37mm Unicam Coded	Ne	Quartz						
	3QNY/As-SH	37mm Self Reversal	Ne	Quartz						
	5QN/As	50mm Standard	Ne	Quartz	18	18	193.7			
	5QN/As-P	50mm Perkin Elmer Coded	Ne	Quartz						
BARIUM Ba	3BAX/Ba	37mm Standard	Ar	Borosilicate	15	12	553.5	350.1	12 x	C
	3BAX/Ba-V	37mm Varian Coded	Ar	Borosilicate				455.4	5 x	
	3BAX/Ba-U	37mm Unicam Coded	Ar	Borosilicate						
	3BAX/Ba-SH	37mm Self Reversal	Ar	Borosilicate						
	5BA/Ba	50mm Standard	Ar	Borosilicate	30	25	553.5			
	5BA/Ba-P	50mm Perkin Elmer Coded	Ar	Borosilicate						
BERYLLIUM Be	3QNY/Be	37mm Standard	Ne	Quartz	15	12	234.9	–		D
	3QNY/Be-V	37mm Varian Coded	Ne	Quartz						
	3QNY/Be-U	37mm Unicam Coded	Ne	Quartz						
	3QNY/Be-SH	37mm Self Reversal	Ne	Quartz						
	5QN/Be	50mm Standard	Ne	Quartz	30	20	234.9	–		
	5QN/Be-P	50mm Perkin Elmer Coded	Ne	Quartz						
BISMUTH Bi	3QNY/Bi	37mm Standard	Ne	Quartz	12	10	223.1	306.8	3.5 x	B
	3QNY/Bi-V	37mm Varian Coded	Ne	Quartz				222.8	2.2 x	
	3QNY/Bi-U	37mm Unicam Coded	Ne	Quartz				206.2	8.0 x	
	3QNY/Bi-SH	37mm Self Reversal	Ne	Quartz				227.7	14 x	
	5QN/Bi	50mm Standard	Ne	Quartz	15	12	223.1	202.1	70 x	
	5QN/Bi-P	50mm Perkin Elmer Coded	Ne	Quartz						
BORON B	3UNX/B	37mm Standard	Ne	UV Glass	15	12	249.8	–		D
	3UNX/B-V	37mm Varian Coded	Ne	UV Glass						
	3UNX/B-U	37mm Unicam Coded	Ne	UV Glass						
	3UNX/B-SH	37mm Self Reversal	Ne	UV Glass						
	5UN/B	50mm Standard	Ne	UV Glass	30	25	249.8	–		
	5UN/B-P	50mm Perkin Elmer Coded	Ne	UV Glass						
CADMIUM Cd	3QNY/Cd	37mm Standard	Ne	Quartz	8	6	228.8	326.1	500 x	C
	3QNY/Cd-V	37mm Varian Coded	Ne	Quartz						
	3QNY/Cd-U	37mm Unicam Coded	Ne	Quartz						
	3QNY/Cd-SH	37mm Self Reversal	Ne	Quartz						
	5QN/Cd	50mm Standard	Ne	Quartz	10	6	228.8			
	5QN/Cd-P	50mm Perkin Elmer Coded	Ne	Quartz						

Hi-Tech lamps

800-229-6509

info@hi-techlamps.com

PART NO.	TYPE	GAS	WINDOW	MAX CURRENT	REC CURRENT	W/LENGTH PRINCIPAL	W/LENGTH ALTERNATE	SENSITIVITY REDUCTION	PERKIN ELMER LEADOUT
CAESIUM									
3BNX/Cs	37mm Standard	Ne	Borosilicate	10	8	852.1	455.5	130 x	B
3BNX/Cs-V	37mm Varian Coded	Ne	Borosilicate						
3BNX/Cs-U	37mm Unicam Coded	Ne	Borosilicate						
3BNX/Cs-SH	37mm Self Reversal	Ne	Borosilicate						
5BN/Cs	50mm Standard	Ne	Borosilicate	10	8	852.1			
5BN/Cs-P	50mm Perkin Elmer Coded	Ne	Borosilicate						
CALCIUM									
3UNX/Ca	37mm Standard	Ne	UV Glass	6	5	422.7	–		C
3UNX/Ca-V	37mm Varian Coded	Ne	UV Glass						
3UNX/Ca-U	37mm Unicam Coded	Ne	UV Glass						
3UNX/Ca-SH	37mm Self Reversal	Ne	UV Glass						
5UN/Ca	50mm Standard	Ne	UV Glass	10	8	422.7	–		
5UN/Ca-P	50mm Perkin Elmer Coded	Ne	UV Glass						
CERIUM									
3UNX/Ce	37mm Standard	Ne	UV Glass	15	15	520.0	569.7		C
3UNX/Ce-V	37mm Varian Coded	Ne	UV Glass						
3UNX/Ce-U	37mm Unicam Coded	Ne	UV Glass						
5UN/Ce	50mm Standard	Ne	UV Glass	20	20	520.0			
CHROMIUM									
3UNX/Cr	37mm Standard	Ne	UV Glass	12	10	357.9	429.0	6 x	C
3UNX/Cr-V	37mm Varian Coded	Ne	UV Glass				359.4	1.5 x	
3UNX/Cr-U	37mm Unicam Coded	Ne	UV Glass				360.3	3 x	
3UNX/Cr-SH	37mm Self Reversal	Ne	UV Glass				425.4	4 x	
5UN/Cr	50mm Standard	Ne	UV Glass	12	10	357.9			
5UN/Cr-P	50mm Perkin Elmer Coded	Ne	UV Glass						
COBALT									
3UNX/Co	37mm Standard	Ne	UV Glass	15	12	240.7	304.4	8 x	D
3UNX/Co-V	37mm Varian Coded	Ne	UV Glass				242.5	1.2 x	
3UNX/Co-U	37mm Unicam Coded	Ne	UV Glass				241.2	2 x	
3UNX/Co-SH	37mm Self Reversal	Ne	UV Glass				252.1	6 x	
5UN/Co	50mm Standard	Ne	UV Glass	40	30	240.7	243.6	6 x	
5UN/Co-P	50mm Perkin Elmer Coded	Ne	UV Glass						
COPPER									
3UNX/Cu	37mm Standard	Ne	UV Glass	5	4	324.8	327.4	2 x	C
3UNX/Cu-V	37mm Varian Coded	Ne	UV Glass				217.9	4 x	
3UNX/Cu-U	37mm Unicam Coded	Ne	UV Glass				216.5	6 x	
3UNX/Cu-SH	37mm Self Reversal	Ne	UV Glass				222.6	20 x	
5UN/Cu	50mm Standard	Ne	UV Glass	20	15	324.8	249.2	100 x	
5UN/Cu-P	50mm Perkin Elmer Coded	Ne	UV Glass				244.2	300 x	
DYSPROSIUM									
3BNX/Dy	37mm Standard	Ne	Borosilicate	15	12	421.2	416.8	10 x	C
3BNX/Dy-V	37mm Varian Coded	Ne	Borosilicate				404.6	1.2 x	
3BNX/Dy-U	37mm Unicam Coded	Ne	Borosilicate				418.7	1.4 x	
5BN/Dy	50mm Standard	Ne	Borosilicate	30	25	421.2	419.5	1.6 x	
5BN/Dy-P	50mm Perkin Elmer Coded	Ne	Borosilicate						
ERBIUM									
3BNX/Er	37mm Standard	Ne	Borosilicate	15	12	400.8	408.8	7 x	C
3BNX/Er-V	37mm Varian Coded	Ne	Borosilicate				386.3	1.5 x	
3BNX/Er-U	37mm Unicam Coded	Ne	Borosilicate				415.1	1.7 x	
5BN/Er	50mm Standard	Ne	Borosilicate	30	25	400.8	389.3	4 x	
5BN/Er-P	50mm Perkin Elmer Coded	Ne	Borosilicate				393.7	8 x	

CAESIUM

Cs

CALCIUM

Ca

CERIUM

Ce

CHROMIUM

Cr

COBALT

Co

COPPER

Cu

DYSPROSIUM

Dy

ERBIUM

Er

hi-Tech lamps

800-229-6509

info@hi-techlamps.com

SINGLE ELEMENT LAMPS

PART NO.	TYPE	GAS	WINDOW	MAX CURRENT	REC CURRENT	W/LENGTH PRINCIPAL	W/LENGTH ALTERNATE	SENSITIVITY REDUCTION	PERKIN ELMER LEADOUT
EUROPIUM									
3BAX/Eu	37mm Standard	Ar	Borosilicate	12	10	459.4	333.4	11 x	B
3BAX/Eu-V	37mm Varian Coded						462.7	1.5 x	
3BAX/Eu-U	37mm Unicam Coded						466.2	1.5 x	
5BA/Eu	50mm Standard			30	25	459.4	321.1	8 x	
5BA/Eu-P	50mm Perkin Elmer Coded						311.1	11 x	
GADOLINIUM									
3UNX/Gd	37mm Standard	Ne	UV Glass	15	12	368.4	419.1	2.5 x	B
3UNX/Gd-V	37mm Varian Coded						368.4	1.2 x	
3UNX/Gd-U	37mm Unicam Coded						478.3	1.2 x	
5UN/Gd	50mm Standard		UV Glass	30	25	368.4	405.8	1.2 x	
5UN/Gd-P	50mm Perkin Elmer Coded		UV Glass				405.5	1.5 x	
GALLIUM									
3UNX/Ga	37mm Standard	Ne	UV Glass	15	12	287.4	403.3	2 x	C
3UNX/Ga-V	37mm Varian Coded	Ne	UV Glass				294.4	1.1 x	
3UNX/Ga-U	37mm Unicam Coded	Ne	UV Glass				417.2	1.5 x	
3UNX/Ga-SH	37mm Self Reversal	Ne	UV Glass				250.0	9 x	
5UN/Ga	50mm Standard	Ne	UV Glass	20	15	287.4	245.0	12 x	
5UN/Ga-P	50mm Perkin Elmer Coded	Ne	UV Glass				272.0	20 x	
GERMANIUM									
3UNX/Ge	37mm Standard	Ne	UV Glass	15	12	265.2	269.1	3 x	C
3UNX/Ge-V	37mm Varian Coded	Ne	UV Glass				259.3	2 x	
3UNX/Ge-U	37mm Unicam Coded	Ne	UV Glass				271.0	2.5 x	
3UNX/Ge-SH	37mm Self Reversal	Ne	UV Glass				275.5	2.5 x	
5UN/Ge	50mm Standard	Ne	UV Glass	30	25	265.2	303.9	25 x	
5UN/Ge-P	50mm Perkin Elmer Coded	Ne	UV Glass						
GOLD									
3UNX/Au	37mm Standard	Ne	UV Glass	10	8	242.8	267.6	2 x	C
3UNX/Au-V	37mm Varian Coded	Ne	UV Glass				312.3	900 x	
3UNX/Au-U	37mm Unicam Coded	Ne	UV Glass				274.8	1100 x	
3UNX/Au-SH	37mm Self Reversal	Ne	UV Glass						
5UN/Au	50mm Standard	Ne	UV Glass	20	10	242.8			
5UN/Au-P	50mm Perkin Elmer Coded	Ne	UV Glass						
HAFNIUM									
3UAX/Hf	37mm Standard	Ar	UV Glass	15	12	307.3	295.1	8 x	C
3UAX/Hf-V	37mm Varian Coded	Ar	UV Glass				377.8	10 x	
3UAX/Hf-U	37mm Unicam Coded	Ar	UV Glass						
5UA/Hf	50mm Standard	Ar	UV Glass	30	25	307.3			
5UA/Hf-P	50mm Perkin Elmer Coded	Ar	UV Glass						
HOLMIUM									
3BNX/Ho	37mm Standard	Ne	Borosilicate	15	12	410.4	417.3	5 x	D
3BNX/Ho-V	37mm Varian Coded	Ne	Borosilicate				405.4	1.3 x	
3BNX/Ho-U	37mm Unicam Coded	Ne	Borosilicate				416.3	2 x	
5BN/Ho	50mm Standard	Ne	Borosilicate	30	25	410.4	404.1	5 x	
5BN/Ho-P	50mm Perkin Elmer Coded	Ne	Borosilicate				410.9	10 x	
INDIUM									
3UNX/In	37mm Standard	Ne	UV Glass	10	8	303.9	451.1	3 x	C
3UNX/In-V	37mm Varian Coded	Ne	UV Glass				325.6	1.1 x	
3UNX/In-U	37mm Unicam Coded	Ne	UV Glass				410.5	2.9 x	
5UN/In	50mm Standard	Ne	UV Glass	25	20	303.9	256.0	12 x	
5UN/In-P	50mm Perkin Elmer Coded	Ne	UV Glass				271.0	20 x	

hi-Tech lamps

800-229-6509

info@hi-techlamps.com

PART NO.	TYPE	GAS	WINDOW	MAX CURRENT	REC CURRENT	W/LENGTH PRINCIPAL	W/LENGTH ALTERNATE	SENSITIVITY REDUCTION	PERKIN ELMER LEADOUT
IRIDIUM									
3QNY/Ir	37mm Standard	Ne	Quartz	15	12	208.9	264.0	3 x	C
3QNY/Ir-V	37mm Varian Coded	Ne	Quartz				266.5	3.5 x	
3QNY/Ir-U	37mm Unicam Coded	Ne	Quartz				237.5	4 x	
3QNY/Ir-SH	37mm Self Reversal	Ne	Quartz				285.0	4.5 x	
5QN/Ir	50mm Standard	Ne	Quartz	30	25	208.9	250.3	5 x	
5QN/Ir-P	50mm Perkin Elmer Coded	Ne	Quartz				254.4	7 x	
IRON									
3UNX/Fe	37mm Standard	Ne	UV Glass	15	12	248.3	372.0	10 x	D
3UNX/Fe-V	37mm Varian Coded	Ne	UV Glass				248.8	2 x	
3UNX/Fe-U	37mm Unicam Coded	Ne	UV Glass				252.3	2 x	
3UNX/Fe-SH	37mm Self Reversal	Ne	UV Glass				271.9	3 x	
5UN/Fe	50mm Standard	Ne	UV Glass	30	30	248.3	302.1	4 x	
5UN/Fe-P	50mm Perkin Elmer Coded	Ne	UV Glass				296.7	11 x	
LANTHANUM									
3UAX/La	37mm Standard	Ar	UV Glass	15	12	550.1	418.7	1.5 x	B
3UAX/La-V	37mm Varian Coded	Ar	UV Glass				365.0	7 x	
3UAX/La-U	37mm Unicam Coded	Ar	UV Glass				392.8	7 x	
3UAX/La-SH	37mm Self Reversal	Ar	UV Glass				403.7	7 x	
5UA/La	50mm Standard	Ar	UV Glass	30	25	550.1	407.9	7 x	
5UA/La-P	50mm Perkin Elmer Coded	Ar	UV Glass						
LEAD									
3QNY/Pb	37mm Standard	Ne	Quartz	10	8	217.0	283.3	2.5 x	C
3QNY/Pb-V	37mm Varian Coded	Ne	Quartz				261.4	40 x	
3QNY/Pb-U	37mm Unicam Coded	Ne	Quartz				368.4	100 x	
3QNY/Pb-SH	37mm Self Reversal	Ne	Quartz						
5QN/Pb	50mm Standard	Ne	Quartz	15	12	217.0			
5QN/Pb-P	50mm Perkin Elmer Coded	Ne	Quartz						
LITHIUM									
3BAX/Li	37mm Standard	Ar	Borosilicate	10	8	670.8	323.3	250 x	C
3BAX/Li-V	37mm Varian Coded	Ar	Borosilicate				610.4	3400 x	
3BAX/Li-U	37mm Unicam Coded	Ar	Borosilicate						
3BAX/Li-SH	37mm Self Reversal	Ar	Borosilicate						
5BA/Li	50mm Standard	Ar	Borosilicate	20	15	670.8			
5BA/Li-P	50mm Perkin Elmer Coded	Ar	Borosilicate						
LUTETIUM									
3UAX/Lu	37mm Standard	Ar	UV Glass	8	6	336.0	337.7	2.2 x	D
3UAX/Lu-V	37mm Varian Coded	Ar	UV Glass				331.2	2.0 x	
3UAX/Lu-U	37mm Unicam Coded	Ar	UV Glass				356.8	2.0 x	
5UA/Lu	50mm Standard	Ar	UV Glass	20	15	336.0	298.9	10 x	
MAGNESIUM									
3QNY/Mg	37mm Standard	Ne	Quartz	6	5	285.2	202.6	40 x	B
3QNY/Mg-V	37mm Varian Coded	Ne	Quartz				279.6	100 x	
3QNY/Mg-U	37mm Unicam Coded	Ne	Quartz						
3QNY/Mg-SH	37mm Self Reversal	Ne	Quartz						
5QN/Mg	50mm Standard	Ne	Quartz	10	6	285.2			
5QN/Mg-P	50mm Perkin Elmer Coded	Ne	Quartz						
MANGANESE									
3UNX/Mn	37mm Standard	Ne	UV Glass	12	10	279.5	403.0	10 x	D
3UNX/Mn-V	37mm Varian Coded	Ne	UV Glass				279.8	1.3 x	
3UNX/Mn-U	37mm Unicam Coded	Ne	UV Glass				280.1	2 x	
3UNX/Mn-SH	37mm Self Reversal	Ne	UV Glass				321.7	2000 x	
5UN/Mn	50mm Standard	Ne	UV Glass	30	20	279.5			
5UN/Mn-P	50mm Perkin Elmer Coded	Ne	UV Glass						

IRIDIUM

Ir

IRON

Fe

LANTHANUM

La

LEAD

Pb

LITHIUM

Li

LUTETIUM

Lu

MAGNESIUM

Mg

MANGANESE

Mn

hi-Tech lamps

800-229-6509

info@hi-techlamps.com

SINGLE ELEMENT LAMPS

PART NO.	TYPE	GAS	WINDOW	MAX CURRENT	REC CURRENT	W/LENGTH PRINCIPAL	W/LENGTH ALTERNATE	SENSITIVITY REDUCTION	PERKIN ELMER LEADOUT	
MERCURY Hg	3UNX/Hg	37mm Standard	Ne	UV Glass	6	5	253.6		D	
	3UNX/Hg-V	37mm Varian Coded	Ne	UV Glass						
	3UNX/Hg-U	37mm Unicam Coded	Ne	UV Glass						
	5UN/Hg	50mm Standard	Ne	UV Glass	8	6	253.6			
	5UN/Hg-P	50mm Perkin Elmer Coded	Ne	UV Glass						
MOLYBDENUM Mo	3UNX/Mo	37mm Standard	Ne	UV Glass	15	12	313.3	390.1	3.8 x	C
	3UNX/Mo-V	37mm Varian Coded	Ne	UV Glass				317.0	1.5 x	
	3UNX/Mo-U	37mm Unicam Coded	Ne	UV Glass				379.8	1.8 x	
	3UNX/Mo-SH	37mm Self Reversal	Ne	UV Glass				319.4	2.0 x	
	5UN/Mo	50mm Standard	Ne	UV Glass	40	30	313.3	386.4	2.2 x	
	5UN/Mo-P	50mm Perkin Elmer Coded	Ne	UV Glass				315.8	4.0 x	
NEODYMIUM Nd	3BNX/Nd	37mm Standard	Ne	Borosilicate	15	12	492.5	490.2	3.2 x	D
	3BNX/Nd-V	37mm Varian Coded	Ne	Borosilicate				463.4	1.3 x	
	3BNX/Nd-U	37mm Unicam Coded	Ne	Borosilicate				471.9	2.0 x	
	5BN/Nd	50mm Standard	Ne	Borosilicate	30	25	492.5	489.7	2.0 x	
	5BN/Nd-P	50mm Perkin Elmer Coded	Ne	Borosilicate						
NICKEL Ni	3QNY/Ni	37mm Standard	Ne	Quartz	15	12	232.0	305.1	4 x	D
	3QNY/Ni-V	37mm Varian Coded	Ne	Quartz				231.1	2 x	
	3QNY/Ni-U	37mm Unicam Coded	Ne	Quartz				341.5	2 x	
	3QNY/Ni-SH	37mm Self Reversal	Ne	Quartz				234.6	4 x	
	5QN/Ni	50mm Standard	Ne	Quartz	30	25	232.0	346.2	8 x	
5QN/Ni-P	50mm Perkin Elmer Coded	Ne	Quartz				351.5	12 x		
NIOBIUM Nb	3UAX/Nb	37mm Standard	Ar	UV Glass	15	12	334.4	358.0	1.1 x	D
	3UAX/Nb-V	37mm Varian Coded	Ar	UV Glass				405.9	1.1 x	
	3UAX/Nb-U	37mm Unicam Coded	Ar	UV Glass				334.9	1.2 x	
	5UA/Nb	50mm Standard	Ar	UV Glass	40	40	334.4	408.0	1.4 x	
	5UA/Nb-P	50mm Perkin Elmer Coded	Ar	UV Glass				335.8	1.5 x	
OSMIUM Os	3UNX/Os	37mm Standard	Ne	UV Glass	10	8	290.9	301.8	2.6 x	C
	3UNX/Os-V	37mm Varian Coded	Ne	UV Glass				305.9	2.0 x	
	3UNX/Os-U	37mm Unicam Coded	Ne	UV Glass				426.1	2.6 x	
	3UNX/Os-SH	37mm Self Reversal	Ne	UV Glass						
	5UN/Os	50mm Standard	Ne	UV Glass	10	8	290.9			
5UN/Os-P	50mm Perkin Elmer Coded	Ne	UV Glass							
PALLADIUM Pd	3UNX/Pd	37mm Standard	Ne	UV Glass	15	12	247.6	340.5	3 x	D
	3UNX/Pd-V	37mm Varian Coded	Ne	UV Glass				276.3	3 x	
	3UNX/Pd-U	37mm Unicam Coded	Ne	UV Glass						
	3UNX/Pd-SH	37mm Self Reversal	Ne	UV Glass						
	5UN/Pd	50mm Standard	Ne	UV Glass	25	20	247.6			
5UN/Pd-P	50mm Perkin Elmer Coded	Ne	UV Glass							
PHOSPHORUS P	3QNY/P	37mm Standard	Ne	Quartz	10	8	213.6	–		C
	3QNY/P-V	37mm Varian Coded	Ne	Quartz						
	3QNY/P-U	37mm Unicam Coded	Ne	Quartz						
	5QN/P	50mm Standard	Ne	Quartz	25	20	213.6	–		
	5QN/P-P	50mm Perkin Elmer Coded	Ne	Quartz						

hi-Tech lamps

800-229-6509

info@hi-techlamps.com

PART NO.	TYPE	GAS	WINDOW	MAX CURRENT	REC CURRENT	W/LENGTH PRINCIPAL	W/LENGTH ALTERNATE	SENSITIVITY REDUCTION	PERKIN ELMER LEADOUT
PLATINIUM									
3UNX/Pt	37mm Standard	Ne	UV Glass	15	12	265.9	299.8	6.0 x	C
3UNX/Pt-V	37mm Varian Coded	Ne	UV Glass				293.0	3.5 x	
3UNX/Pt-U	37mm Unicam Coded	Ne	UV Glass				306.5	2.0 x	
3UNX/Pt-SH	37mm Self Reversal	Ne	UV Glass				262.8	2.5 x	
5UN/Pt	50mm Standard	Ne	UV Glass	25	20	265.9	283.0	3.5 x	
5UN/Pt-P	50mm Perkin Elmer Coded	Ne	UV Glass				273.4	4.0 x	
POTASSIUM									
3BNX/K	37mm Standard	Ne	Borosilicate	8	6	766.5	404.4	200 x	C
3BNX/K-V	37mm Varian Coded	Ne	Borosilicate				769.9	2 x	
3BNX/K-U	37mm Unicam Coded	Ne	Borosilicate				407.7	200 x	
3BNX/K-SH	37mm Self Reversal	Ne	Borosilicate						
5BN/K	50mm Standard	Ne	Borosilicate	12	10	766.5			
5BN/K-P	50mm Perkin Elmer Coded	Ne	Borosilicate						
PRASEODYMIUM									
3BNX/Pr	37mm Standard	Ne	Borosilicate	15	12	495.1	492.5	2.3 x	C
3BNX/Pr-V	37mm Varian Coded	Ne	Borosilicate				513.3	1.5 x	
3BNX/Pr-U	37mm Unicam Coded	Ne	Borosilicate				473.7	2.3 x	
5BN/Pr	50mm Standard	Ne	Borosilicate	30	25	495.1	502.7	2.5 x	
5BN/Pr-P	50mm Perkin Elmer Coded	Ne	Borosilicate				504.6	4.0 x	
RHENIUM									
3UAX/Re	37mm Standard	Ar	UV Glass	15	12	346.1	345.2	2.4 x	C
3UAX/Re-V	37mm Varian Coded	Ar	UV Glass				346.5	1.5 x	
3UAX/Re-U	37mm Unicam Coded	Ar	UV Glass						
3UAX/Re-SH	37mm Self Reversal	Ar	UV Glass						
5UA/Re	50mm Standard	Ar	UV Glass	30	25	346.1			
5UA/Re-P	50mm Perkin Elmer Coded	Ar	UV Glass						
RHODIUM									
3UAX/Rh	37mm Standard	Ar	UV Glass	15	12	343.5	365.8	5.0 x	D
3UAX/Rh-V	37mm Varian Coded	Ar	UV Glass				369.2	1.7 x	
3UAX/Rh-U	37mm Unicam Coded	Ar	UV Glass				339.7	2.5 x	
3UAX/Rh-SH	37mm Self Reversal	Ar	UV Glass				370.1	8.0 x	
5UA/Rh	50mm Standard	Ar	UV Glass	30	25	343.5	350.7	4.0 x	
5UA/Rh-P	50mm Perkin Elmer Coded	Ar	UV Glass				328.1	10 x	
RUBIDIUM									
3BNX/Rb	37mm Standard	Ne	Borosilicate	10	8	780.0	794.8	2.5 x	C
3BNX/Rb-V	37mm Varian Coded	Ne	Borosilicate				420.2	100 x	
3BNX/Rb-U	37mm Unicam Coded	Ne	Borosilicate				421.6	250 x	
5BN/Rb	50mm Standard	Ne	Borosilicate	10	8	780.0			
5BN/Rb-P	50mm Perkin Elmer Coded	Ne	Borosilicate						
RUTHENIUM									
3UNX/Ru	37mm Standard	Ne	UV Glass	15	12	349.9	392.6	10 x	D
3UNX/Ru-V	37mm Varian Coded	Ne	UV Glass				379.9	2 x	
3UNX/Ru-U	37mm Unicam Coded	Ne	UV Glass						
5UN/Ru	50mm Standard	Ne	UV Glass	30	25	349.9			
5UN/Ru-P	50mm Perkin Elmer Coded	Ne	UV Glass						
SAMARIUM									
3UNX/Sm	37mm Standard	Ne	UV Glass	15	12	429.7	476.0	1.4 x	D
3UNX/Sm-V	37mm Varian Coded	Ne	UV Glass				472.8	2.0 x	
3UNX/Sm-U	37mm Unicam Coded	Ne	UV Glass				520.1	1.6 x	
5UN/Sm	50mm Standard	Ne	UV Glass	30	25	429.7	478.3	2.1 x	
5UN/Sm-P	50mm Perkin Elmer Coded	Ne	UV Glass				511.7	2.4 x	

PLATINIUM

Pt

POTASSIUM

K

PRASEODYMIUM

Pr

RHENIUM

Re

RHODIUM

Rh

RUBIDIUM

Rb

RUTHENIUM

Ru

SAMARIUM

Sm

hi-Tech lamps

800-229-6509

info@hi-techlamps.com

SINGLE ELEMENT LAMPS

	PART NO.	TYPE	GAS	WINDOW	MAX CURRENT	REC CURRENT	W/LENGTH PRINCIPAL	W/LENGTH ALTERNATE	SENSITIVITY REDUCTION	PERKIN ELMER LEADOUT
SCANDIUM Sc	3UNX/Sc	37mm Standard	Ne	UV Glass	15	12	391.2	408.2	6 x	C
	3UNX/Sc-V	37mm Varian Coded	Ne	UV Glass				390.8	1.2 x	
	3UNX/Sc-U	37mm Unicam Coded	Ne	UV Glass				402.4	1.4 x	
	5UN/Sc	50mm Standard	Ne	UV Glass	30	25	391.2	402.0	1.8 x	
	5UN/Sc-P	50mm Perkin Elmer Coded	Ne	UV Glass				327.0	4.0 x	
SELENIUM Se	3QNY/Se	37mm Standard	Ne	Quartz	15	15	196.0	204.0	3 x	C
	3QNY/Se-V	37mm Varian Coded	Ne	Quartz				206.3	12 x	
	3QNY/Se-U	37mm Unicam Coded	Ne	Quartz				207.5	50 x	
	3QNY/Se-SH	37mm Self Reversal	Ne	Quartz						
	5QN/Se	50mm Standard	Ne	Quartz	15	15	196.0			
	5QN/Se-P	50mm Perkin Elmer Coded	Ne	Quartz						
SILICON Si	3QNY/Si	37mm Standard	Ne	Quartz	15	12	251.6	250.7	2.6 x	D
	3QNY/Si-V	37mm Varian Coded	Ne	Quartz				251.4	3.4 x	
	3QNY/Si-U	37mm Unicam Coded	Ne	Quartz				252.9	3.4 x	
	3QNY/Si-SH	37mm Self Reversal	Ne	Quartz				252.4	3.8 x	
	5QN/Si	50mm Standard	Ne	Quartz	40	35	251.6	221.7	4.5 x	
	5QN/Si-P	50mm Perkin Elmer Coded	Ne	Quartz				221.1	10 x	
SILVER Ag	3UAX/Ag	37mm Standard	Ar	UV Glass	4	3	328.1	338.3	2.0 x	D
	3UAX/Ag-V	37mm Varian Coded	Ar	UV Glass						
	3UAX/Ag-U	37mm Unicam Coded	Ar	UV Glass						
	3UAX/Ag-SH	37mm Self Reversal	Ar	UV Glass						
	5UA/Ag	50mm Standard	Ar	UV Glass	10	5	328.1			
	5UA/Ag-P	50mm Perkin Elmer Coded	Ar	UV Glass						
SODIUM Na	3UNX/Na	37mm Standard	Ne	UV Glass	8	6	589.0	330.3	300 x	C
	3UNX/Na-V	37mm Varian Coded	Ne	UV Glass				589.6	2.0 x	
	3UNX/Na-U	37mm Unicam Coded	Ne	UV Glass						
	3UNX/Na-SH	37mm Self Reversal	Ne	UV Glass						
	5UN/Na	50mm Standard	Ne	UV Glass	10	8	589.0			
	5UN/Na-P	50mm Perkin Elmer Coded	Ne	UV Glass						
STRONTIUM Sr	3BAX/Sr	37mm Standard	Ar	Borosilicate	12	12	460.7	–		C
	3BAX/Sr-V	37mm Varian Coded	Ar	Borosilicate						
	3BAX/Sr-U	37mm Unicam Coded	Ar	Borosilicate						
	3BAX/Sr-SH	37mm Self Reversal	Ar	Borosilicate						
	5BA/Sr	50mm Standard	Ar	Borosilicate	20	15	460.7	–		
	5BA/Sr-P	50mm Perkin Elmer Coded	Ar	Borosilicate						
TANTALUM Ta	3UNX/Ta	37mm Standard	Ne	UV Glass	15	12	271.5	277.6	2 x	C
	3UNX/Ta-V	37mm Varian Coded	Ne	UV Glass				260.9	2 x	
	3UNX/Ta-U	37mm Unicam Coded	Ne	UV Glass				255.9	2.5 x	
	5UN/Ta	50mm Standard	Ne	UV Glass	40	30	271.5	293.4	2.8 x	
	5UN/Ta-P	50mm Perkin Elmer Coded	Ne	UV Glass				269.8	3.0 x	

hi-Tech lamps

800-229-6509

info@hi-techlamps.com

PART NO.	TYPE	GAS	WINDOW	MAX CURRENT	REC CURRENT	W/LENGTH PRINCIPAL	W/LENGTH ALTERNATE	SENSITIVITY REDUCTION	PERKIN ELMER LEADOUT
TELLURIUM									
3QNY/Te	37mm Standard	Ne	Quartz	15	15	214.3	225.9	8.0 x	B
3QNY/Te-V	37mm Varian Coded	Ne	Quartz				238.5	50 x	
3QNY/Te-U	37mm Unicam Coded	Ne	Quartz						
3QNY/Te-SH	37mm Self Reversal	Ne	Quartz						
5QN/Te	50mm Standard	Ne	Quartz	30	30	214.3			
5QN/Te-P	50mm Perkin Elmer Coded	Ne	Quartz						
TERBIUM									
3BNX/Tb	37mm Standard	Ne	Borosilicate	15	12	432.7	431.9	1.2 x	C
3BNX/Tb-V	37mm Varian Coded	Ne	Borosilicate				410.6	3.0 x	
3BNX/Tb-U	37mm Unicam Coded	Ne	Borosilicate				390.1	1.5 x	
5BN/Tb	50mm Standard	Ne	Borosilicate	30	25	432.7	406.2	1.8 x	
5BN/Tb-P	50mm Perkin Elmer Coded	Ne	Borosilicate				433.9	1.8 x	
THALLIUM									
3UNX/Tl	37mm Standard	Ne	UV Glass	10	8	276.8	377.6	2.5 x	C
3UNX/Tl-V	37mm Varian Coded	Ne	UV Glass				238.0	6.5 x	
3UNX/Tl-U	37mm Unicam Coded	Ne	UV Glass				258.0	25 x	
3UNX/Tl-SH	37mm Self Reversal	Ne	UV Glass						
5UN/Tl	50mm Standard	Ne	UV Glass	10	8	276.8			
5UN/Tl-P	50mm Perkin Elmer Coded	Ne	UV Glass						
THORIUM									
3UNX/Th	37mm Standard	Ne	UV Glass	15	15	371.9			C
5UN/Th	50mm Standard	Ne	UV Glass	25	25				
THULIUM									
3UNX/Tm	37mm Standard	Ne	UV Glass	15	12	371.8	375.2	5.0 x	C
3UNX/Tm-V	37mm Varian Coded	Ne	UV Glass				410.6	1.5 x	
3UNX/Tm-U	37mm Unicam Coded	Ne	UV Glass				374.4	1.8 x	
5UN/Tm	50mm Standard	Ne	UV Glass	30	25		409.4	1.8 x	
5UN/Tm-P	50mm Perkin Elmer Coded	Ne	UV Glass				418.8	3.0 x	
TIN									
3QNY/Sn	37mm Standard	Ne	Quartz	15	12	224.6	300.9	7 x	C
3QNY/Sn-V	37mm Varian Coded	Ne	Quartz				286.3	1.5 x	
3QNY/Sn-U	37mm Unicam Coded	Ne	Quartz				235.5	2 x	
3QNY/Sn-SH	37mm Self Reversal	Ne	Quartz				270.7	2.5 x	
5QN/Sn	50mm Standard	Ne	Quartz	30	30	224.6	303.4	3.5 x	
5QN/Sn-P	50mm Perkin Elmer Coded	Ne	Quartz				254.7	5.5 x	
TITANIUM									
3UNX/Ti	37mm Standard	Ne	UV Glass	15	12	365.4	375.3	2.0 x	C
3UNX/Ti-V	37mm Varian Coded	Ne	UV Glass				374.1	2.5 x	
3UNX/Ti-U	37mm Unicam Coded	Ne	UV Glass				399.0	2.5 x	
3UNX/Ti-SH	37mm Self Reversal	Ne	UV Glass				364.3	1.1 x	
5UN/Ti	50mm Standard	Ne	UV Glass	30	25	365.4	320.0	1.2 x	
5UN/Ti-P	50mm Perkin Elmer Coded	Ne	UV Glass				363.6	1.3 x	
TUNGSTEN									
3UNX/W	37mm Standard	Ne	UV Glass	15	12	255.1	400.9	2.5 x	C
3UNX/W-V	37mm Varian Coded	Ne	UV Glass				268.1	1.8 x	
3UNX/W-U	37mm Unicam Coded	Ne	UV Glass				272.4	1.8 x	
3UNX/W-SH	37mm Self Reversal	Ne	UV Glass				294.4	1.8 x	
5UN/W	50mm Standard	Ne	UV Glass	40	30	255.1	294.7	1.9 x	
5UN/W-P	50mm Perkin Elmer Coded	Ne	UV Glass				283.1	2.5 x	

TELLURIUM

Te

TERBIUM

Tb

THALLIUM

Tl

THORIUM

Th

THULIUM

Tm

TIN

Sn

TITANIUM

Ti

TUNGSTEN

W

hi-Tech lamps

800-229-6509

info@hi-techlamps.com

SINGLE ELEMENT LAMPS

	PART NO.	TYPE	GAS	WINDOW	MAX CURRENT	REC CURRENT	W/LENGTH PRINCIPAL	W/LENGTH ALTERNATE	SENSITIVITY REDUCTION	PERKIN ELMER LEADOUT
URANIUM U	3UAX/U	37mm Standard	Ar	UV Glass	15	15	358.5	351.5	2.5 x	C
	3UAX/U-V	37mm Varian Coded	Ar	UV Glass				358.5	0.7 x	
	3UAX/U-U	37mm Unicam Coded	Ar	UV Glass				394.4	2.5 x	
	5UA/U	50mm Standard	Ar	UV Glass	25	25	358.5	348.9	3.0 x	
	5UA/U-P	50mm Perkin Elmer Coded	Ar	UV Glass						
VANADIUM V	3UNX/V	37mm Standard	Ne	UV Glass	15	12	318.5	306.6	3.0 x	D
	3UNX/V-V	37mm Varian Coded	Ne	UV Glass				306.1	2.8 x	
	3UNX/V-U	37mm Unicam Coded	Ne	UV Glass				305.6	3.2 x	
	3UNX/V-SH	37mm Self Reversal	Ne	UV Glass				437.9	4.5 x	
	5UN/V	50mm Standard	Ne	UV Glass	40	30	318.5	320.2	6.4 x	
	5UN/V-P	50mm Perkin Elmer Coded	Ne	UV Glass				385.6	6.5 x	
YTTERBIUM Yb	3UNX/Yb	37mm Standard	Ne	UV Glass	15	12	398.8	246.4	5.0 x	D
	3UNX/Yb-V	37mm Varian Coded	Ne	UV Glass				346.5	3.0 x	
	3UNX/Yb-U	37mm Unicam Coded	Ne	UV Glass				267.2	5.0 x	
	5UN/Yb	50mm Standard	Ne	UV Glass	30	25	398.8			
	5UN/Yb-P	50mm Perkin Elmer Coded	Ne	UV Glass						
YTTRIUM Y	3BNX/Y	37mm Standard	Ne	Borosilicate	15	12	410.2	362.1	2.2 x	C
	3BNX/Y-V	37mm Varian Coded	Ne	Borosilicate				407.7	1.2 x	
	3BNX/Y-U	37mm Unicam Coded	Ne	Borosilicate				412.8	1.2 x	
	5BN/Y	50mm Standard	Ne	Borosilicate	30	25	410.2	414.8	2.2 x	
	5BN/Y-P	50mm Perkin Elmer Coded	Ne	Borosilicate						
ZINC Zn	3QNY/Zn	37mm Standard	Ne	Quartz	10	8	213.9	307.6	4000 x	D
	3QNY/Zn-V	37mm Varian Coded	Ne	Quartz						
	3QNY/Zn-U	37mm Unicam Coded	Ne	Quartz						
	3QNY/Zn-SH	37mm Self Reversal	Ne	Quartz						
	5QN/Zn	50mm Standard	Ne	Quartz	20	15	213.9			
	5QN/Zn-P	50mm Perkin Elmer Coded	Ne	Quartz						
ZIRCONIUM Zr	3UNX/Zr	37mm Standard	Ne	UV Glass	15	12	360.1	301.2	1.8 x	D
	3UNX/Zr-V	37mm Varian Coded	Ne	UV Glass				303.1	1.5 x	
	3UNX/Zr-U	37mm Unicam Coded	Ne	UV Glass				352.0	1.6 x	
	3UNX/Zr-SH	37mm Self Reversal	Ne	UV Glass				354.8	1.6 x	
	5UN/Zr	50mm Standard	Ne	UV Glass	40	30	360.1	298.5	2.0 x	
	5UN/Zr-P	50mm Perkin Elmer Coded	Ne	UV Glass						
DEUTERIUM D ₂	3QDY/D ₂	37mm Standard	D ₂	Quartz	25		Continuum			

hi-Tech lamps

800-229-6509

info@hi-techlamps.com

PART NO.	TYPE	GAS	WINDOW	MAX CURRENT	REC CURRENT	PERKIN ELMER LEADOUT
ALUMINIUM						
3QNY/Al/Ca	37mm Standard	Ne	Quartz	10	8	C
5QN/Al/Ca	50mm Standard	Ne	Quartz	20	15	
3QNY/Al/Mg	37mm Standard	Ne	Quartz	10	8	C
3QNY/Al/Mg-U	37mm Unicam Coded	Ne	Quartz			
5QN/Al/Mg	50mm Standard	Ne	Quartz	20	15	
3QNY/Al/Si	37mm Standard	Ne	Quartz	15	12	C
3QNY/Al/Si-U	37mm Unicam Coded	Ne	Quartz			
5QN/Al/Si	50mm Standard	Ne	Quartz	20	16	
3QNY/Al/Ti	37mm Standard	Ne	Quartz	15	12	C
3QNY/Al/Ti-U	37mm Unicam Coded	Ne	Quartz			
5QN/Al/Ti	50mm Standard	Ne	Quartz	20	16	
BARIUM						
3QNY/Ba/Sr	37mm Standard	Ne	Quartz	15	12	C
3QNY/Ba/Sr-U	37mm Unicam Coded	Ne	Quartz			
5QN/Ba/Sr	50mm Standard	Ne	Quartz	15	12	
CADMIUM						
3QNY/Cd/Zn	37mm Standard	Ne	Quartz	8	6	C
3QNY/Cd/Zn-U	37mm Unicam Coded	Ne	Quartz			
5QN/Cd/Zn	50mm Standard	Ne	Quartz	8	6	
CALCIUM						
3QNY/Ca/Ba	37mm Standard	Ne	Quartz	15	12	C
3QNY/Ca/Ba-U	37mm Unicam Coded	Ne	Quartz			
5QN/Ca/Ba	50mm Standard	Ne	Quartz	15	12	
3QNY/Ca/Mg	37mm Standard	Ne	Quartz	6	5	C
3QNY/Ca/Mg-V	37mm Varian Coded	Ne	Quartz			
3QNY/Ca/Mg-U	37mm Unicam Coded	Ne	Quartz			
5QN/Ca/Mg	50mm Standard	Ne	Quartz	20	15	
5QN/Ca/Mg-P	37mm Perkin Elmer Coded	Ne	Quartz			
3QNY/Ca/Si	37mm Standard	Ne	Quartz	15	12	C
3QNY/Ca/Si-U	37mm Unicam Coded	Ne	Quartz			
5QN/Ca/Si	50mm Standard	Ne	Quartz	20	15	
3QNY/Ca/Sr	37mm Standard	Ne	Quartz	15	12	C
3QNY/Ca/Sr-U	37mm Unicam Coded	Ne	Quartz			
5QN/Ca/Sr	50mm Standard	Ne	Quartz	15	12	
3QNY/Ca/Zn	37mm Standard	Ne	Quartz	10	8	C
3QNY/Ca/Zn-U	37mm Unicam Coded	Ne	Quartz			
5QN/Ca/Zn	50mm Standard	Ne	Quartz	20	15	
5QN/Ca/Zn-P	50mm Perkin Elmer Coded	Ne	Quartz			
CHROMIUM						
3QNY/Cr/Co	37mm Standard	Ne	Quartz	10	8	C
5QN/Cr/Co	50mm Standard	Ne	Quartz	30	25	
3QNY/Cr/Cu	37mm Standard	Ne	Quartz	10	8	C
3QNY/Cr/Cu-U	37mm Unicam Coded	Ne	Quartz			
5QN/Cr/Cu	50mm Standard	Ne	Quartz	30	25	
3QNY/Cr/Fe	37mm Standard	Ne	Quartz	10	8	C
5QN/Cr/Fe	50mm Standard	Ne	Quartz	30	25	
3QNY/Cr/Mn	37mm Standard	Ne	Quartz	10	8	C
3QNY/Cr/Mn-U	37mm Unicam Coded	Ne	Quartz			
5QN/Cr/Mn	50mm Standard	Ne	Quartz	30	25	
3QNY/Cr/Mo	37mm Standard	Ne	Quartz	15	12	C
3QNY/Cr/Mo-U	37mm Unicam Coded	Ne	Quartz			
5QN/Cr/Mo	50mm Standard	Ne	Quartz	30	25	
3QNY/Cr/Ni	37mm Standard	Ne	Quartz	10	8	C
3QNY/Cr/Ni-U	37mm Unicam Coded	Ne	Quartz			
5QN/Cr/Ni	50mm Standard	Ne	Quartz	30	25	
COBALT						
3QNY/Co/Cu	37mm Standard	Ne	Quartz	10	8	C
3QNY/Co/Cu-U	37mm Unicam Coded	Ne	Quartz			
5QN/Co/Cu	50mm Standard	Ne	Quartz	30	25	
3QNY/Co/Fe	37mm Standard	Ne	Quartz	10	8	C
3QNY/Co/Fe-U	37mm Unicam Coded	Ne	Quartz			
5QN/Co/Fe	50mm Standard	Ne	Quartz	30	25	
3QNY/Co/Mn	37mm Standard	Ne	Quartz	10	8	C
3QNY/Co/Mn-U	37mm Unicam Coded	Ne	Quartz			
5QN/Co/Mn	50mm Standard	Ne	Quartz	30	25	

TWO ELEMENTS

ALUMINIUM

Al + Ca

Al + Mg

Al + Si

Al + Ti

BARIUM

Ba + Sr

CADMIUM

Cd + Zn

CALCIUM

Ca + Ba

Ca + Mg

Ca + Si

Ca + Sr

Ca + Zn

CHROMIUM

Cr + Co

Cr + Cu

Cr + Fe

Cr + Mn

Cr + Mo

Cr + Ni

COBALT

Co + Cu

Co + Fe

Co + Mn

MULTI-ELEMENT LAMPS

TWO
ELEMENTS

COBALT

Co + Mo

PART NO.	TYPE	GAS	WINDOW	MAX CURRENT	REC CURRENT	PERKIN ELMER LEADOUT
3QNY/Co/Mo	37mm Standard	Ne	Quartz	10	8	C
3QNY/Co/Mo-U	37mm Unicam Coded	Ne	Quartz			
5QN/Co/Mo	50mm Standard	Ne	Quartz	30	25	

Co + Ni

3QNY/Co/Ni	37mm Standard	Ne	Quartz	10	8	C
3QNY/Co/Ni-U	37mm Unicam Coded	Ne	Quartz			
5QN/Co/Ni	50mm Standard	Ne	Quartz	30	25	

COPPER

Cu + Fe

3QNY/Cu/Fe	37mm Standard	Ne	Quartz	10	8	C
3QNY/Cu/Fe-U	37mm Unicam Coded	Ne	Quartz			
5QN/Cu/Fe	50mm Standard	Ne	Quartz	30	25	

Cu + Mn

3QNY/Cu/Mn	37mm Standard	Ne	Quartz	10	8	C
3QNY/Cu/Mn-U	37mm Unicam Coded	Ne	Quartz			

Cu + Mo

3QNY/Cu/Mo	37mm Standard	Ne	Quartz	10	8	C
JQN/Cu/Mo	50mm Standard	Ne	Quartz	30	25	

Cu + Ni

3QNY/Cu/Ni	37mm Standard	Ne	Quartz	10	8	C
3QNY/Cu/Ni-U	37mm Unicam Coded	Ne	Quartz			

Cu + Zn

5QN/Cu/Ni	50mm Standard	Ne	Quartz	30	25	
3QNY/Cu/Zn	37mm Standard	Ne	Quartz	10	8	C
3QNY/Cu/Zn-V	37mm Varian Coded	Ne	Quartz			
3QNY/Cu/Zn-U	37mm Unicam Coded	Ne	Quartz			
5QN/Cu/Zn	50mm Standard	Ne	Quartz	20	15	

GOLD

Au + Cu

3QNY/Au/Cu	37mm Standard	Ne	Quartz	10	8	C
3QNY/Au/Cu-U	37mm Unicam Coded	Ne	Quartz			

Au + Ni

5QN/Au/Cu	50mm Standard	Ne	Quartz	15	12	
3QNY/Au/Ni	37mm Standard	Ne	Quartz	10	8	C
3QNY/Au/Ni-U	37mm Unicam Coded	Ne	Quartz			

Au + Pt

5QN/Au/Ni	50mm Standard	Ne	Quartz	15	12	
3QNY/Au/Pt	37mm Standard	Ne	Quartz	10	8	C
3QNY/Au/Pt-U	37mm Unicam Coded	Ne	Quartz			

Au + Ag

5QN/Au/Pt	50mm Standard	Ne	Quartz	15	12	
3QNY/Au/Ag	37mm Standard	Ne	Quartz	10	8	C
3QNY/Au/Ag-U	37mm Unicam Coded	Ne	Quartz			
5QN/Au/Ag	50mm Standard	Ne	Quartz	20	15	
5QN/Au/Ag-P	50mm Perkin Elmer Coded	Ne	Quartz			

IRON

Fe + Mn

3QNY/Fe/Mn	37mm Standard	Ne	Quartz	10	8	C
3QNY/Fe/Mn-U	37mm Unicam Coded	Ne	Quartz			

Fe + Mo

5QN/Fe/Mn	50mm Standard	Ne	Quartz	30	25	
3QNY/Fe/Mo	37mm Standard	Ne	Quartz	10	8	C
5QN/Fe/Mo	50mm Standard	Ne	Quartz	30	25	

Fe + Ni

3QNY/Fe/Ni	37mm Standard	Ne	Quartz	10	8	C
3QNY/Fe/Ni-U	37mm Unicam Coded	Ne	Quartz			

Fe + Zn

5QN/Fe/Ni	50mm Standard	Ne	Quartz	30	25	
3QNY/Fe/Zn	37mm Standard	Ne	Quartz	10	8	C
3QNY/Fe/Zn-U	37mm Unicam Coded	Ne	Quartz			
5QN/Fe/Zn	50mm Standard	Ne	Quartz	20	15	

MAGNESIUM

Mg + Si

3QNY/Mg/Si	37mm Standard	Ne	Quartz	15	12	C
3QNY/Mg/Si-U	37mm Unicam Coded	Ne	Quartz			
5QN/Mg/Si	50mm Standard	Ne	Quartz	20	15	

hi-Tech lamps

800-229-6509

info@hi-techlamps.com

PART NO.	TYPE	GAS	WINDOW	MAX CURRENT	REC CURRENT	PERKIN ELMER LEADOUT
MANGANESE						
3QNY/Mn/Mo	37mm Standard	Ne	Quartz	10	8	C
5QN/Mn/Mo	50mm Standard	Ne	Quartz	30	25	
3QNY/Mn/Ni	37mm Standard	Ne	Quartz	10	8	C
3QNY/Mn/Ni-U	37mm Unicam Coded	Ne	Quartz			
5QN/Mn/Ni	50mm Standard	Ne	Quartz	30	25	
3QNY/Mn/Zn	37mm Standard	Ne	Quartz	10	8	C
3QNY/Mn/Zn-U	37mm Unicam Coded	Ne	Quartz			
5QN/Mn/Zn	50mm Standard	Ne	Quartz	20	15	
PLATINUM						
3QNY/Pt/Ag	37mm Standard	Ne	Quartz	10	8	C
3QNY/Pt/Ag-U	37mm Unicam Coded	Ne	Quartz			
5QN/Pt/Ag	50mm Standard	Ne	Quartz	15	12	
SILICON						
3QNY/Si/Ti	37mm Standard	Ne	Quartz	15	12	C
3QNY/Si/Ti-U	37mm Unicam Coded	Ne	Quartz			
5QN/Si/Ti	50mm Standard	Ne	Quartz	20	16	
SILVER						
3QNY/Ag/Cr	37mm Standard	Ne	Quartz	10	8	C
3QNY/Ag/Cr-U	37mm Unicam Coded	Ne	Quartz			
5QN/Ag/Cr	50mm Standard	Ne	Quartz	20	16	
3QNY/Ag/Cu	37mm Standard	Ne	Quartz	10	8	C
3QNY/Ag/Cu-U	37mm Unicam Coded	Ne	Quartz			
5QN/Ag/Cu	50mm Standard	Ne	Quartz	25	16	
SODIUM						
3UNX/Na/K	37mm Standard	Ne	UV Glass	8	6	C
3UNX/Na/K-U	37mm Unicam Coded	Ne	UV Glass			
3UNX/Na/K-V	37mm Varian Coded	Ne	UV Glass			
5UN/Na/K	50mm Standard	Ne	UV Glass	12	10	
5UN/Na/K-P	50mm Perkin Elmer Coded	Ne	UV Glass			
ALUMINIUM						
3QNY/Al/Ca/Mg	37mm Standard	Ne	Quartz	10	8	C
5QN/Al/Ca/Mg	50mm Standard	Ne	Quartz	20	15	
5QN/Al/Ca/Mg-P	50mm Perkin Elmer Coded	Ne	Quartz			
3QNY/Al/Si/Ti	37mm Standard	Ne	Quartz	15	12	C
3QNY/Al/Si/Ti-U	37mm Unicam Coded	Ne	Quartz			
5QN/Al/Si/Ti	50mm Standard	Ne	Quartz	20	16	
ANTIMONY						
3QNY/Sb/As/Bi	37mm Standard	Ne	Quartz	15	12	C
5QN/Sb/As/Bi	50mm Standard	Ne	Quartz	20	16	
ARSENIC						
3QNY/As/Se/Te	37mm Standard	Ne	Quartz	10	10	C
5QN/As/Se/Te	50mm Standard	Ne	Quartz	15	15	
CALCIUM						
3QNY/Ca/Ba/Sr	37mm Standard	Ne	Quartz	15	12	C
3QNY/Ca/Ba/Sr-U	37mm Unicam Coded	Ne	Quartz			
5QN/Ca/Ba/Sr	50mm Standard	Ne	Quartz	20	15	
3QNY/Ca/Mg/Si	37mm Standard	Ne	Quartz	15	12	C
3QNY/Ca/Mg/Si-U	37mm Unicam Coded	Ne	Quartz			
5QN/Ca/Mg/Si	50mm Standard	Ne	Quartz	20	15	
3QNY/Ca/Mg/Zn	37mm Standard	Ne	Quartz	10	8	C
5QN/Ca/Mg/Zn	50mm Standard	Ne	Quartz	20	20	
5QN/Ca/Mg/Zn-P	50mm Perkin Elmer Coded	Ne	Quartz			

TWO ELEMENTS

MANGANESE

Mn + Mo

Mn + Ni

Mn + Zn

PLATINUM

Pt + Ag

SILICON

Si + Ti

SILVER

Ag + Cr

Ag + Cu

SODIUM

Na + K

THREE ELEMENTS

ALUMINIUM

Al + Ca + Mg

Al + Si + Ti

ANTIMONY

Sb + As + Bi

ARSENIC

As + Se + Te

CALCIUM

Ca + Ba + Sr

Ca + Mg + Si

Ca + Mg + Zn

hi-Tech lamps

800-229-6509

info@hi-techlamps.com

MULTI-ELEMENT LAMPS

THREE
ELEMENTS

CHROMIUM

Cr + Cu Co

Cr + Co Fe

Cr + Co Mn

Cr + Co Ni

Cr + Cu Fe

Cr + Cu Mn

Cr + Cu Ni

Cr + Fe Mn

Cr + Fe Ni

Cr + Mn Ni

COBALT

Co + Cu Fe

Co + Cu Mn

Co + Mn Ni

COPPER

Cu + Fe Mn

Cu + Fe Ni

Cu + Fe Zn

Cu + Mn Ni

Cu + Mn Zn

GOLD

Au + Cu Ni

Au + Pt Ag

IRON

Fe + Mn Ni

PART NO.	TYPE	GAS	WINDOW	MAX CURRENT	REC CURRENT	PERKIN ELMER LEADOUT
3QNY/Cr/Cu/Co	37mm Standard	Ne	Quartz	10	8	C
5QN/Cr/Cu/Co	50mm Standard	Ne	Quartz	30	25	
3QNY/Cr/Co/Fe	37mm Standard	Ne	Quartz	10	8	C
5QN/Cr/Co/Fe	50mm Standard	Ne	Quartz	30	25	
3QNY/Cr/Co/Mn	37mm Standard	Ne	Quartz	10	8	C
5QN/Cr/Co/Mn	50mm Standard	Ne	Quartz	30	25	
3QNY/Cr/Co/Ni	37mm Standard	Ne	Quartz	10	8	C
5QN/Cr/Co/Ni	50mm Standard	Ne	Quartz	30	25	
3QNY/Cr/Cu/Fe	37mm Standard	Ne	Quartz	10	8	C
5QN/Cr/Cu/Fe	50mm Standard	Ne	Quartz	30	25	
3QNY/Cr/Cu/Mn	37mm Standard	Ne	Quartz	10	8	C
3QNY/Cr/Cu/Mn-U	37mm Unicam Coded	Ne	Quartz			
5QN/Cr/Cu/Mn	50mm Standard	Ne	Quartz	30	25	
3QNY/Cr/Cu/Ni	37mm Standard	Ne	Quartz	10	8	C
3QNY/Cr/Cu/Ni-U	37mm Unicam Coded	Ne	Quartz			
5QN/Cr/Cu/Ni	50mm Standard	Ne	Quartz	30	25	
3QNY/Cr/Fe/Mn	37mm Standard	Ne	Quartz	10	8	C
5QN/Cr/Fe/Mn	50mm Standard	Ne	Quartz	30	25	
3QNY/Cr/Fe/Ni	37mm Standard	Ne	Quartz	10	8	C
5QN/Cr/Fe/Ni	50mm Standard	Ne	Quartz	30	25	
3QNY/Cr/Mn/Ni	37mm Standard	Ne	Quartz	10	8	C
3QNY/Cr/Mn/Ni-U	37mm Unicam Coded	Ne	Quartz			
5QN/Cr/Mn/Ni	50mm Standard	Ne	Quartz	30	25	
3QNY/Co/Cu/Fe	37mm Standard	Ne	Quartz	10	8	C
3QNY/Co/Cu/Fe-U	37mm Unicam Coded	Ne	Quartz			
5QN/Co/Cu/Fe	50mm Standard	Ne	Quartz	30	25	
3QNY/Co/Cu/Mn	37mm Standard	Ne	Quartz	10	8	C
5QN/Co/Cu/Mn	50mm Standard	Ne	Quartz	30	25	
3QNY/Co/Mn/Ni	37mm Standard	Ne	Quartz	10	8	C
3QNY/Co/Mn/Ni-U	37mm Unicam Coded	Ne	Quartz			
5QN/Co/Mn/Ni	50mm Standard	Ne	Quartz	30	25	
3QNY/Cu/Fe/Mn	37mm Standard	Ne	Quartz	10	8	C
3QNY/Cu/Fe/Mn-U	37mm Unicam Coded	Ne	Quartz			
5QN/Cu/Fe/Mn	50mm Standard	Ne	Quartz	30	25	
3QNY/Cu/Fe/Ni	37mm Standard	Ne	Quartz	10	8	C
3QNY/Cu/Fe/Ni-U	50mm Unicam Coded	Ne	Quartz			
5QN/Cu/Fe/Ni	50mm Standard	Ne	Quartz	30	25	
3QNY/Cu/Fe/Zn	37mm Standard	Ne	Quartz	10	8	C
3QNY/Cu/Fe/Zn-U	37mm Unicam Coded	Ne	Quartz			
5QN/Cu/Fe/Zn	50mm Standard	Ne	Quartz	20	15	
3QNY/Cu/Mn/Ni	37mm Standard	Ne	Quartz	10	8	C
3QNY/Cu/Mn/Ni-U	37mm Unicam Coded	Ne	Quartz			
5QN/Cu/Mn/Ni	50mm Standard	Ne	Quartz	30	25	
3QNY/Cu/Mn/Zn	37mm Standard	Ne	Quartz	10	8	C
3QNY/Cu/Mn/Zn-U	37mm Unicam Coded	Ne	Quartz			
5QN/Cu/Mn/Zn	50mm Standard	Ne	Quartz	20	15	
3QNY/Au/Cu/Ni	37mm Standard	Ne	Quartz	10	8	C
3QNY/Au/Cu/Ni-U	37mm Unicam Coded	Ne	Quartz			
5QN/Au/Cu/Ni	50mm Standard	Ne	Quartz	15	12	
3QNY/Au/Pt/Ag	37mm Standard	Ne	Quartz	10	8	C
3QNY/Au/Pt/Ag-U	37mm Unicam Coded	Ne	Quartz			
5QN/Au/Pt/Ag	50mm Standard	Ne	Quartz	15	12	
3QNY/Fe/Mn/Ni	37mm Standard	Ne	Quartz	10	8	C
3QNY/Fe/Mn/Ni-U	37mm Unicam Coded	Ne	Quartz			
5QN/Fe/Mn/Ni	50mm Standard	Ne	Quartz	30	25	

Hi-Tech lamps

800-229-6509

info@hi-techlamps.com

PART NO.	TYPE	GAS	WINDOW	MAX CURRENT	REC CURRENT	PERKIN ELMER LEADOUT
IRON						
3QNY/Fe/Mn/Zn	37mm Standard	Ne	Quartz	10	8	C
3QNY/Fe/Mn/Zn-U	37mm Unicam Coded	Ne	Quartz			
5QN/Fe/Mn/Zn	50mm Standard	Ne	Quartz	20	15	
MOLYBDENUM						
3QNY/Mo/Cr/Co	37mm Standard	Ne	Quartz	10	8	C
5QN/Mo/Cr/Co	50mm Standard	Ne	Quartz	30	25	
3QNY/Mo/Cr/Cu	37mm Standard	Ne	Quartz	10	8	C
5QN/Mo/Cr/Cu	50mm Standard	Ne	Quartz	30	25	
3QNY/Mo/Cr/Fe	37mm Standard	Ne	Quartz	10	8	C
5QN/Mo/Cr/Fe	50mm Standard	Ne	Quartz	30	25	
3QNY/Mo/Cr/Mn	37mm Standard	Ne	Quartz	10	8	C
5QN/Mo/Cr/Mn	50mm Standard	Ne	Quartz	30	25	
3QNY/Mo/Co/Cu	37mm Standard	Ne	Quartz	10	8	C
5QN/Mo/Co/Cu	50mm Standard	Ne	Quartz	30	25	
3QNY/Mo/Co/Mn	37mm Standard	Ne	Quartz	10	8	C
5QN/Mo/Co/Mn	50mm Standard	Ne	Quartz	30	25	
3QNY/Mo/Co/Fe	37mm Standard	Ne	Quartz	10	8	C
5QN/Mo/Co/Fe	50mm Standard	Ne	Quartz	30	25	
3QNY/Mo/Cu/Fe	37mm Standard	Ne	Quartz	10	8	C
5QN/Mo/Cu/Fe	50mm Standard	Ne	Quartz	30	25	
3QNY/Mo/Cu/Mn	37mm Standard	Ne	Quartz	10	8	C
5QN/Mo/Cu/Mn	50mm Standard	Ne	Quartz	30	25	
3QNY/Mo/Fe/Mn	37mm Standard	Ne	Quartz	10	8	C
5QN/Mo/Fe/Mn	50mm Standard	Ne	Quartz	30	25	
SILVER						
3QNY/Ag/Cr/Cu	37mm Standard	Ne	Quartz	10	8	C
3QNY/Ag/Cr/Cu-U	37mm Unicam Coded	Ne	Quartz			
5QN/Ag/Cr/Cu	50mm Standard	Ne	Quartz	25	20	
3QNY/Ag/Cu/Ni	37mm Standard	Ne	Quartz	10	8	C
5QN/Ag/Cu/Ni	50mm Standard	Ne	Quartz	25	20	
ALUMINIUM						
3QNY/Al/Ca/Fe/Mg	37mm Standard	Ne	Quartz	15	12	C
5QN/Al/Ca/Fe/Mg	50mm Standard	Ne	Quartz	20	16	
3QNY/Al/Ca/Li/Mg	37mm Standard	Ne	Quartz	10	8	C
5QN/Al/Ca/Li/Mg	50mm Standard	Ne	Quartz	20	16	
BARIUM						
3QNY/Ba/Ca/Mg/Sr	37mm Standard	Ne	Quartz	15	12	C
5QN/Ba/Ca/Mg/Sr	50mm Standard	Ne	Quartz	20	15	
CHROMIUM						
3QNY/Cr/Co/Cu/Fe	37mm Standard	Ne	Quartz	10	8	C
5QN/Cr/Co/Cu/Fe	50mm Standard	Ne	Quartz	30	25	
3QNY/Cr/Co/Cu/Mn	37mm Standard	Ne	Quartz	10	8	C
5QN/Cr/Co/Cu/Mn	50mm Standard	Ne	Quartz	30	25	
3QNY/Cr/Co/Cu/Ni	37mm Standard	Ne	Quartz	10	8	C
5QN/Cr/Co/Cu/Ni	50mm Standard	Ne	Quartz	30	25	
3QNY/Cr/Co/Fe/Mn	37mm Standard	Ne	Quartz	10	8	C
5QN/Cr/Co/Fe/Mn	50mm Standard	Ne	Quartz	30	25	
3QNY/Cr/Co/Fe/Ni	37mm Standard	Ne	Quartz	10	8	C
5QN/Cr/Co/Fe/Ni	50mm Standard	Ne	Quartz	30	25	
3QNY/Cr/Co/Mn/Ni	37mm Standard	Ne	Quartz	10	8	C
5QN/Cr/Co/Mn/Ni	50mm Standard	Ne	Quartz	30	25	
3QNY/Cr/Cu/Fe/Mn	37mm Standard	Ne	Quartz	10	8	C
5QN/Cr/Cu/Fe/Mn	50mm Standard	Ne	Quartz	30	25	
3QNY/Cr/Cu/Fe/Ni	37mm Standard	Ne	Quartz	10	8	C
5QN/Cr/Cu/Fe/Ni	50mm Standard	Ne	Quartz	30	25	

THREE ELEMENTS**IRON**

Fe + Mn Zn

MOLYBDENUM

Mo + Cr Co

Mo + Cr Cu

Mo + Cr Fe

Mo + Cr Mn

Mo + Co Cu

Mo + Co Mn

Mo + Co Fe

Mo + Cu Fe

Mo + Cu Mn

Mo + Fe Mn

SILVER

Ag + Cr Cu

Ag + Cu Ni

FOUR ELEMENTS**ALUMINIUM**

Al + Ca Fe Mg

Al + Ca Li Mg

Ba + Ca Mg Sr

CHROMIUM

Cr + Co Cu Fe

Cr + Co Cu Mn

Cr + Co Cu Ni

Cr + Co Fe Mn

Cr + Co Fe Ni

Cr + Co Mn Ni

Cr + Cu Fe Mn

Cr + Cu Fe Ni

hi-Tech lamps

800-229-6509

info@hi-techlamps.com

MULTI-ELEMENT LAMPS

FOUR
ELEMENTS

CHROMIUM

Cr + Cu Mn Ni

Cr + Cu Ni Ag

Cr + Fe Mn Ni

COBALT

Co + Cu Fe Mn

Co + Cu Fe Ni

Co + Cu Mn Ni

Co + Fe Mn Ni

COPPER

Cu + Fe Mn Ni

Cu + Fe Mn Zn

Cu + Fe Ni Ag

MOLYBDENUM

Mo + Co Cu Fe

Mo + Co Cu Mn

Mo + Co Fe Mn

Mo + Cu Fe Mn

FIVE
ELEMENTS

CHROMIUM

Cr + Co Cu Fe Mn

Cr + Co Cu Fe Ni

Cr + Co Cu Mn Ni

Cr + Co Fe Mn Ni

Cr + Cu Fe Mn Ni

Cr + Cu Fe Ni Ag

PART NO.	TYPE	GAS	WINDOW	MAX CURRENT	REC CURRENT	PERKIN ELMER LEADOUT
3QNY/Cr/Cu/Mn/Ni	37mm Standard	Ne	Quartz	10	8	C
3QNY/Cr/Cu/Mn/Ni-U	37mm Unicam Coded	Ne	Quartz			
5QN/Cr/Cu/Mn/Ni	50mm Standard	Ne	Quartz	30	25	
3QNY/Cr/Cu/Ni/Ag	37mm Standard	Ne	Quartz	10	8	C
5QN/Cr/Cu/Ni/Ag	50mm Standard	Ne	Quartz	20	16	
5QN/Cr/Cu/Ni/Ag-P	50mm Perkin Elmer Coded	Ne	Quartz			
3QNY/Cr/Fe/Mn/Ni	37mm Standard	Ne	Quartz	10	8	C
5QN/Cr/Fe/Mn/Ni	50mm Standard	Ne	Quartz	30	25	
3QNY/Co/Cu/Fe/Mn	37mm Standard	Ne	Quartz	10	8	C
3QNY/Co/Cu/Fe/Mn-U	37mm Unicam Coded	Ne	Quartz			
5QN/Co/Cu/Fe/Mn	50mm Standard	Ne	Quartz	30	25	
3QNY/Co/Cu/Fe/Ni	37mm Standard	Ne	Quartz	10	8	C
5QN/Co/Cu/Fe/Ni	50mm Standard	Ne	Quartz	30	25	
3QNY/Co/Cu/Mn/Ni	37mm Standard	Ne	Quartz	10	8	C
3QNY/Co/Cu/Mn/Ni-U	37mm Unicam Coded	Ne	Quartz			
5QN/Co/Cu/Mn/Ni	50mm Standard	Ne	Quartz	30	25	
3QNY/Co/Fe/Mn/Ni	37mm Standard	Ne	Quartz	10	8	C
3QNY/Co/Fe/Mn/Ni-U	37mm Unicam Coded	Ne	Quartz			
5QN/Co/Fe/Mn/Ni	50mm Standard	Ne	Quartz	30	25	
3QNY/Cu/Fe/Mn/Ni	37mm Standard	Ne	Quartz	10	8	C
3QNY/Cu/Fe/Mn/Ni-U	37mm Unicam Coded	Ne	Quartz			
5QN/Cu/Fe/Mn/Ni	50mm Standard	Ne	Quartz	30	25	
3QNY/Cu/Fe/Mn/Zn	37mm Standard	Ne	Quartz	10	8	C
3QNY/Cu/Fe/Mn/Zn-U	37mm Unicam Coded	Ne	Quartz			
5QN/Cu/Fe/Mn/Zn	50mm Standard	Ne	Quartz	20	15	
5QN/Cu/Fe/Mn/Zn-P	50mm Perkin Elmer Coded	Ne	Quartz			
3QNY/Cu/Fe/Ni/Ag	37mm Standard	Ne	Quartz	10	8	C
5QN/Cu/Fe/Ni/Ag	50mm Standard	Ne	Quartz	20	16	
3QNY/Mo/Co/Cu/Fe	37mm Standard	Ne	Quartz	10	8	C
5QN/Mo/Co/Cu/Fe	50mm Standard	Ne	Quartz	30	25	
3QNY/Mo/Co/Cu/Mn	37mm Standard	Ne	Quartz	10	8	C
5QN/Mo/Co/Cu/Mn	50mm Standard	Ne	Quartz	30	25	
3QNY/Mo/Co/Fe/Mn	37mm Standard	Ne	Quartz	10	8	C
5QN/Mo/Co/Fe/Mn	50mm Standard	Ne	Quartz	30	25	
3QNY/Mo/Cu/Fe/Mn	37mm Standard	Ne	Quartz	10	8	C
5QN/Mo/Cu/Fe/Mn	50mm Standard	Ne	Quartz	30	25	
3QNY/Cr/Co/Cu/Fe/Mn	37mm Standard	Ne	Quartz	10	8	C
5QN/Cr/Co/Cu/Fe/Mn	50mm Standard	Ne	Quartz	30	25	
3QNY/Cr/Co/Cu/Fe/Ni	37mm Standard	Ne	Quartz	10	8	C
5QN/Cr/Co/Cu/Fe/Ni	50mm Standard	Ne	Quartz	30	25	
3QNY/Cr/Co/Cu/Mn/Ni	37mm Standard	Ne	Quartz	10	8	C
5QN/Cr/Co/Cu/Mn/Ni	50mm Standard	Ne	Quartz	30	25	
5QN/Cr/Co/Cu/Mn/Ni-P	50mm Perkin Elmer Coded	Ne	Quartz			
3QNY/Cr/Co/Fe/Mn/Ni	37mm Standard	Ne	Quartz	10	8	C
5QN/Cr/Co/Fe/Mn/Ni	50mm Standard	Ne	Quartz	30	25	
3QNY/Cr/Cu/Fe/Mn/Ni	37mm Standard	Ne	Quartz	10	8	C
5QN/Cr/Cu/Fe/Mn/Ni	50mm Standard	Ne	Quartz	30	25	
3QNY/Cr/Cu/Fe/Ni/Ag	37mm Standard	Ne	Quartz	10	8	C
5QN/Cr/Cu/Fe/Ni/Ag	50mm Standard	Ne	Quartz	20	16	
5QN/Cr/Cu/Fe/Ni/Ag-P	50mm Perkin Elmer Coded	Ne	Quartz			

hi-Tech lamps

800-229-6509

info@hi-techlamps.com

MULTI-ELEMENT LAMPS

PART NO.	TYPE	GAS	WINDOW	MAX CURRENT	REC CURRENT	PERKIN ELMER LEADOUT
COBALT						
3QNY/Co/Cu/Fe/Mn/Mo	37mm Standard	Ne	Quartz	10	8	C
5QN/Co/Cu/Fe/Mn/Mo	50mm Standard	Ne	Quartz	30	25	
5QN/Co/Cu/Fe/Mn/Mo-P	50mm Perkin Elmer Coded	Ne	Quartz			
3QNY/Co/Cu/Fe/Mn/Ni	37mm Standard	Ne	Quartz	10	8	C
5QN/Co/Cu/Fe/Mn/Ni	50mm Standard	Ne	Quartz	30	25	
CHROMIUM						
3QNY/Cr/Co/Cu/Fe/Mn/Mo	37mm Standard	Ne	Quartz	10	8	C
5QN/Cr/Co/Cu/Fe/Mn/Mo	50mm Standard	Ne	Quartz	30	25	
3QNY/Cr/Co/Cu/Fe/Mn/Ni	37mm Standard	Ne	Quartz	10	8	C
3QNY/Cr/Co/Cu/Fe/Mn/Ni-V	37mm Varian Coded	Ne	Quartz			
5QN/Cr/Co/Cu/Fe/Mn/Ni	50mm Standard	Ne	Quartz	30	25	
5QN/Cr/Co/Cu/Fe/Mn/Ni-P	50mm Perkin Elmer Coded	Ne	Quartz			
ALUMINIUM						
3QNY/Al/Ca/Cu/Fe/Mg/Si/Zn	37mm Standard	Ne	Quartz	15	15	C
5QN/Al/Ca/Cu/Fe/Mg/Si/Zn	50mm Standard	Ne	Quartz	30	25	
5QN/Al/Ca/Cu/Fe/Mg/Si/Zn-P	50mm Perkin Elmer Coded	Ne	Quartz			

FIVE ELEMENTS

COBALT

Co + Cu Fe Mn Mo

Co + Cu Fe Mn Ni

SIX ELEMENTS

CHROMIUM

Cr + Co Cu Fe Mn

Cr + Co Cu Fe Mn Mo

Cr + Co Cu Fe Mn Ni

SEVEN ELEMENTS

ALUMINIUM

Al + Ca Cu Fe Mg

Al + Ca Cu Fe Mg Zn Si

From time to time Cathodeon will introduce new Multi-Element combinations. This space is provided to make additions when notified.

PART NO.	TYPE	GAS	WINDOW	MAX CURRENT	REC CURRENT	PERKIN ELMER LEADOUT

hi-Tech lamps
 800-229-6509
 info@hi-techlamps.com

GETTING THE BEST FROM YOUR HOLLOW CATHODE LAMPS

YOUR INSTRUMENT

The condition of your instrument optics and its electronics have a significant affect on the reproducibility and especially the ultimate sensitivity possible when using a Cathodeon hollow cathode lamp. Regular cleaning, maintenance and replacement of the optical path is essential to high sensitivity analysis especially in the deep ultra violet where solarisation can considerably reduce throughput with time. Equally the photomultiplier may not be linearly sensitive over the complete spectral range, it being quite common for instruments to be specially fitted with photomultipliers that are more sensitive over specific wavelength ranges. As hollow cathode lamps produce such a wavelength specific output, regular calibration of the monochromator is essential for correct setting of wavelength and it is not unusual for the lamp to peak on a reading that is different from the book figure due to wear in the mechanical drive that moves the grating wavelength selector.

OPERATING CURRENT

Each hollow cathode lamp has a maximum current which should not be exceeded. Exceeding the limit will considerably reduce the usable life of the lamp and may damage the cathode by sputtering off excess material or even melting some of the more volatile alloys and elements. The current shown on a 37mm hollow cathode lamp is the maximum current at which the lamp should be run in an instrument using a modulated power supply typical of most manufacturers. The current shown on a 50mm lamp is the maximum current at which the lamp should be used in an instrument with a continuous power supply typical of most Perkin Elmer instruments. It is possible, with the correct adapters, to run a 37mm lamp in a Perkin Elmer instrument with a continuous power supply in which instance the current recommended for 50mm lamps should be used. A few Perkin Elmer models have a modulated power supply. Reference to the instrument user manual will indicate the type of power supply in the instrument, if a modulated supply is present then the lamp should be run at the current recommended for a 37mm lamp. In general lamps should be run at 75% of their maximum current to achieve best precision and 65 - 75% to achieve their maximum sensitivity. However the performance of some elements is not materially affected by operation anywhere between 65 and 100%. Lamps should not be operated below 50% maximum current as, in all but a few cases, stability and noise levels deteriorate significantly. Indeed elements with naturally low outputs such as Arsenic, Tin,

Fig 10 Types of misalignment

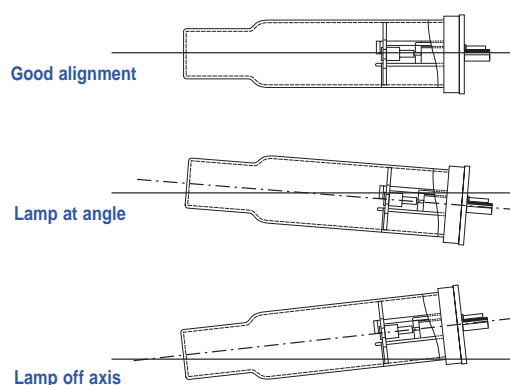

Antimony, Bismuth and Selenium would be too noisy for analysis at the detection limit at anything other than maximum current.

STABILISATION

After striking the lamp or following a change in operating current most lamps will require a warm-up period before full stability is obtained. Depending upon the element, the warm-up time can be between 5 and 30 minutes. If lamps have not been used for a considerable time or have been stored before initial use they may require somewhat longer than usual to stabilise. This period will normally be around 2 hours but an overnight run may prove to be the most efficient way of restoring full stability. Softer elements with lower melting points such as lead especially benefit from this practise. For optimum performance, on receipt of a new lamp it is also good practise to run it in the instrument to acclimatise the lamp to the particular power supply.

Fig 11 Typical warm up curves

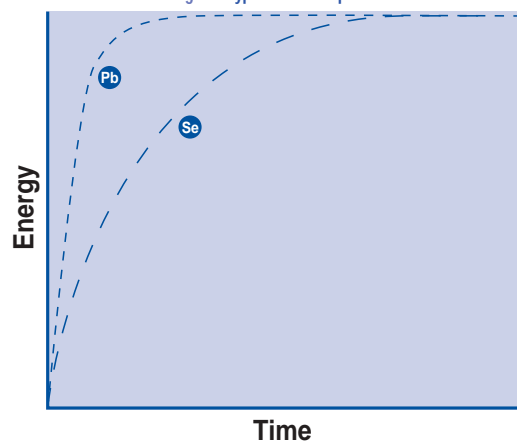

ALIGNMENT

A hollow cathode lamp produces a very narrow beam of light; if not aligned correctly the output from the lamp will not fill the entrance slit and there will be an apparent loss in signal and the noise levels will increase. Low throughput and high noise may indicate that the lamp is misaligned in one of the ways shown below. The lamp should then be re-aligned until maximum signal output has been obtained.

OUTPUT

Low output is often cited when lamps are returned or discarded despite otherwise working well for chemical analysis. It is in fact common for an old lamp to have a slightly higher fundamental output than the new lamp. This increase in output comes about from a combination of two mechanisms, one of which is a decrease in the internal pressure of the lamp caused by the gradual usage of the fill gas. In addition material movement within the lamp may increase the output by closing the hole in the hollow cathode and concentrating the beam. The same material movement may also cause a counteracting effect through a diminution of the transmittance of the window.

CHEMICAL SENSITIVITY

Sensitivity is defined as the concentration of the element in ug/ml in aqueous solution which gives an absorbance of 0.0044 (1% absorption). It is useful for calculating the calibration range of the instrument, which is usually in the range of 20 - 200 times the sensitivity value. It should be noted that

APPLICATIONS

After striking the lamp or following a change in operating current most lamps will require a warm-up period before full stability is obtained.

the chemical sensitivity is dependant on the instrument and the set up such as burner height, flame chemistry and nebuliser positioning. For this reason reference should be made to the instrument manual for the recommended conditions and expected resultant sensitivity.

DETECTION LIMIT

The detection limit is defined as the concentration of the element in ug/ml which gives a signal equal to three times the standard deviation of a series of at least 10 determinations at or near the blank level (95% confidence). In practical terms concentrations of less than 10 times the detection limit cannot be measured with any accuracy. The determination of this limit is particularly sensitive to noise levels so optimisation of output is key in ensuring as low a detection limit as possible.

CURRENT VS OUTPUT VS CHEMICAL SENSITIVITY

For optimum use of the lamp for its end purpose, chemical analysis, Cathodeon aims to provide the best ratio of output : chemical sensitivity : life : noise and stability. The general relationship between these factors demonstrates that lower current gives increased chemical sensitivity but also increased noise levels and decreased output. Higher current will conversely reduce the noise, increase the output but will also reduce the chemical sensitivity.

Each element and its matrix presents a unique problem, requiring the analyst to determine the optimal conditions for each particular analysis. The result will inevitably be a compromise in which some output has to be sacrificed in favour of other factors considered more important to the analysis.

Fig 12 Current vs Output vs Chemical Sensitivity vs Noise

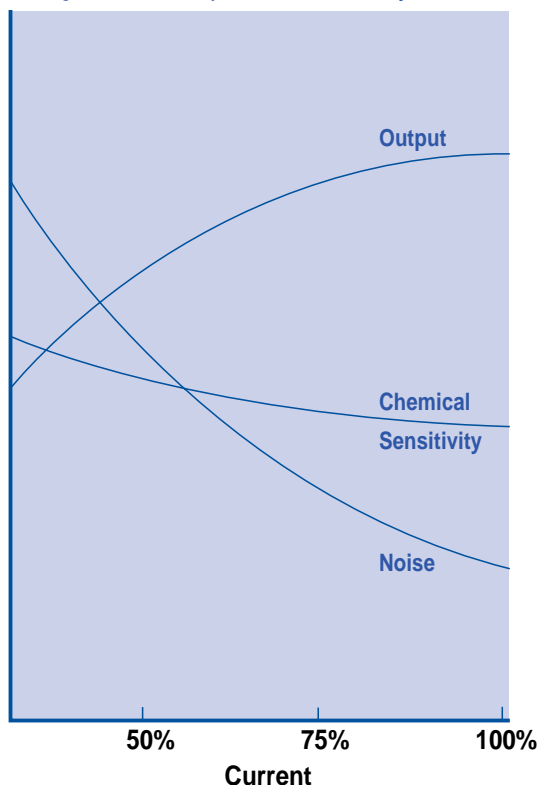

HELPFUL HINTS ON THE USE OF HOLLOW CATHODE LAMPS

Safety

Hollow cathode lamps used in normal atomic absorption applications and to instrument manufacturers' specification provide very little risk, however the lamps are under reduced pressure, can emit UV light and may contain toxic metals. For this reason Cathodeon has produced a safety label for each lamp in four languages. These labels are attached to the lamp and contain each hazard associated with that particular lamp. Each user should carry out specific risk assessment before use in accordance with their national safety laws.

Cleanliness

Care should be taken not to touch the output window, as finger marks can affect the output. If the window is contaminated it can be cleaned by careful use of a clean lens tissue moistened with acetone or alcohol.

Disposal

In the event of breakage of the lamp the hazard label indicates all the prime element contained in the cathode of the lamp; all parts of the lamp should be treated as the prime element for disposal purposes. The disposal must comply with local and national laws relating to the particular element. Cathodeon in its manufacturing takes great care to minimise the impact on the environment from both materials and processing and to achieve this have instigated systems for minimum waste production and disposal of waste in a responsible and legal manner. Any customer finding difficulty in disposing used lamps locally can return them to us, carriage paid, and we will dispose through our system.

USEFUL LOCAL PHONE NUMBERS:

Safety Office:

Disposal Agent:

Local Authority:

GETTING THE BEST FROM YOUR HOLLOW CATHODE LAMPS

APPLICATIONS

Cathodeon aims to provide the best ratio of output to chemical sensitivity to life to noise and stability.

HOLLOW CATHODE LAMP SUPPLY

TYPE C610

The Cathodeon hollow cathode lamp power supply C610 is current stabilized and specifically designed to operate all Cathodeon hollow cathode lamps.

Special Features

The supply is fully automatic in operation and provides warning of malfunction of the lamp. The supply has low noise and drift characteristics and has been designed to allow accurate setting of the lamp current. For this reason, the current adjustment is in two ranges to allow high precision setting at low current levels where it is most important for consistent performance of the hollow cathode lamp. Provision is made for the external modulation of lamp current.

SPECIFICATIONS

Output Current

Adjustable in two ranges.

2—10mA calibrated in 0.2mA divs.

10—50mA calibrated in 1mA divs.

The supply automatically selects the low current range on switch on. The high range is then selected by a push switch on the front panel and a warning light denotes use of the high current range. The supply automatically reverts to the low range if the current is reduced below 10mA whilst the selector is in the high range position.

Current Stability

Better than 0.05% after initial 15mins warm up.

Output Voltage

Nominal 530V strike voltage is available.

Current Modulation

BNC input socket provided for an external 5V TTL drive pulse to reduce the current to a nominal 10% of the set current, with a minimum of 2mA to preserve lamp stability.

Maximum modulation frequency 500Hz. Higher frequencies are possible if waveform degradation can be tolerated.

Indicators

Mains on — Green

Lamp on (i.e. 2mA) — Amber

High Range selected — Amber

External modulation on — Amber

Fault—showing short circuit condition in either the hollow cathode lamp or connecting leads — Red

Connections

The output to the hollow cathode lamp is via a Neutrix connector ('AXR'/'XLR' series) fitted to the rear panel of the supply.

Mains Input

110, 130, 220, 240V rms 50/60Hz.

Selected on rear panel.

Fuse 1A slow blow for 240V.

(1A for 110V.)

Dimensions

260mm x 250mm x 140mm.

Weight 4.13kg.

OPERATION

The hollow cathode lamp should be connected and the power switched on. If the fault lamp is illuminated there is a short circuit in the hollow cathode lamp or its connections and these should be checked. Select the required lamp current. The supply will automatically start in the low (2—10mA) range. If currents in excess of 10mA are required, turn the control beyond the 2—10mA scale mark and press the high range button on the front panel. This will select the high range and illuminate the high range warning lamp. If the current is reduced to below 10mA, the supply will automatically reset the low range. If modulation of the lamp current is required, a 5V TTL drive pulse may be applied to the BNC socket on the rear panel. A switch is fitted to the front panel to turn modulation on or off as required. A positive 5V signal reduces lamp current to a nominal 10% of set operating current. The scale markings indicate the peak current when the lamp is being modulated.

APPLICATIONS

The supply has low noise and drift characteristics and has been designed to allow accurate setting of the lamp current.

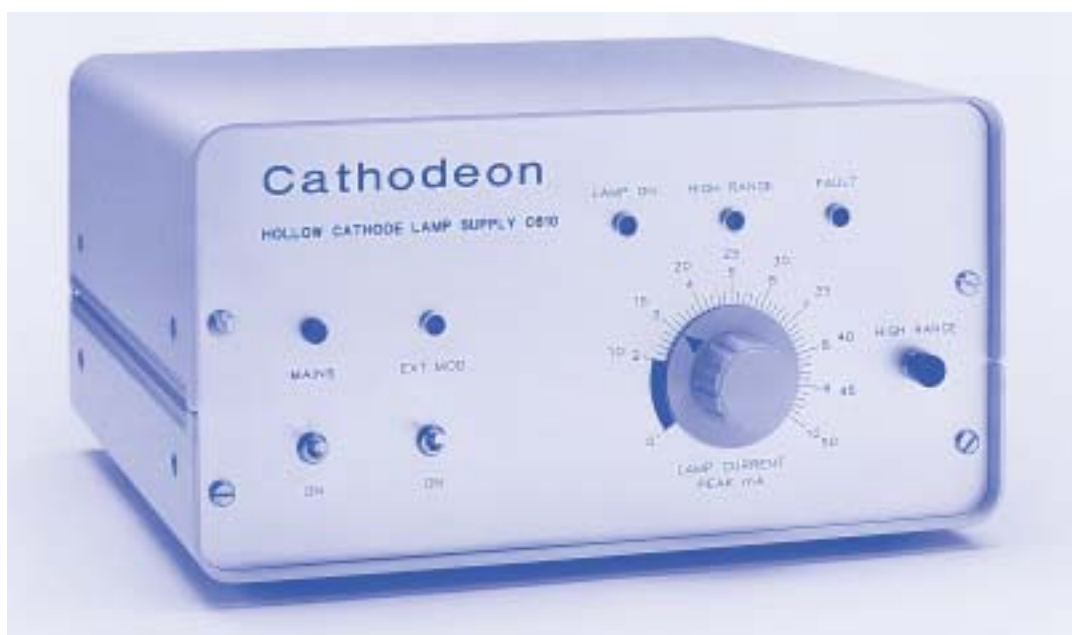

Group	Ia	IIa	IIIb	IVb	Vb	VIIb	VIII	IIb	IIIa	IVa	Va	VIa	VIIa	0	
Period 1	1.008 Hydrogen H													4.002 Helium He	
2	6.940 Lithium Li 7.016 6.941 323.3 10 (10)	9.012 Beryllium Be 234.9 - 15 (15)				24.305 Magnesium Mg 283.2 202.6 4 (6)				12.011 Carbon C 26.982 249.8 15 (25)	14.007 Nitrogen N - 10 (10)	15.100 Oxygen O - 15 (25)	18.998 Fluorine F - 15 (25)	20.179 Neon Ne - 10 (10)	
3	22.990 Sodium Na 39.098 8 (8)	24.305 Magnesium Mg 283.2 202.6 4 (6)				54.938 Manganese Mn 44.956 4 (6)				28.086 Silicon Si 350.7 15 (25)	30.974 Phosphorus P - 10 (10)	32.060 Sulfur S - 15 (25)	35.453 Chlorine Cl - 15 (25)	39.948 Argon Ar - 10 (10)	
4	39.098 Potassium K 76.5 404.4 8 (8)	40.080 Calcium Ca 422.7 6 (6)	44.956 Scandium Sc 39.2 498.2 15 (25)	47.900 Titanium Ti 364.3 399.0 15 (20)	50.942 Vanadium V 318.4 365.5 15 (20)	51.996 Chromium Cr 352.0 424.0 12 (12)	58.933 Cobalt Co 240.7 391.4 15 (30)	63.546 Copper Cu 354.8 370.4 10 (10)	65.380 Zinc Zn 297.4 370.6 10 (10)	72.590 Germanium Ge 352.1 15 (20)	74.922 Arsenic As - 12 (15)	78.960 Selenium Se - 15 (15)	79.904 Bromine Br - 15 (15)	83.800 Krypton Kr - 10 (10)	
5	85.468 Rubidium Rb 794.8 10 (10)	87.620 Strontium Sr 460.7 - 12 (12)	88.906 Yttrium Y 402.2 382.1 15 (25)	91.220 Zirconium Zr 360.1 351.9 15 (30)	92.906 Niobium Nb 334.4 368.0 15 (30)	101.070 Ruthenium Ru 348.5 362.5 15 (30)	102.906 Rhodium Rh 344.5 368.5 15 (15)	107.868 Silver Ag 384.1 388.3 4 (5)	112.410 Cadmium Cd 288.1 366.1 8 (8)	118.690 Tin Sn 224.6/233.4 300.9 12 (12)	121.750 Antimony Sb 206.8/217.6 211.1 12 (25)	127.600 Tellurium Te 214.3 225.9 6 (15)	126.905 Iodine I - 15 (15)	131.300 Xenon Xe - 10 (10)	
6	132.905 Cesium Cs 892.1 455.5 10 (10)	137.330 Barium Ba 563.6 350.1 15 (25)	138.906 Lanthanum La 501.1 487.7 15 (25)	178.490 Hafnium Hf 307.3 288.8 15 (25)	180.948 Tantalum Ta 271.5 271.6 15 (25)	190.230 Osmium Os 200.9 301.8 10 (10)	192.220 Iridium Ir 228.9 284.0 15 (20)	196.967 Platinum Pt 265.9 289.8 15 (20)	196.967 Gold Au 242.8 267.6 10 (10)	200.590 Mercury Hg 200.6 200.6 6 (6)	207.200 Lead Pb 207.2 207.2 10 (10)	208.980 Bismuth Bi 208.98 208.98 10 (10)	209 Polonium Po - 10 (10)	210 Astatine At - 10 (10)	222 Radium Rn - 10 (10)
7	223 Francium Fr	226.025 Radium Ra	227 Actinium Ac	260 Rutherfordium Rf											

Element Symbol
 Alternative Wavelength nm
 Maximum current
 Recommended Wavelength nm
 Maximum DC current for 2 Peakon Elmer Lamps*

Atomic Weight
 Magnesium
 Magnesium
 Magnesium
 Magnesium

* In the case of Peakon Elmer instruments, if the RMS display indicates current value that indicates current, the lamp should be operated at approximately half the quoted maximum lamp current.

Hollow Cathode Lamps of these elements are available from Cathodeon

Group	Ia	IIa	IIIb	IVb	Vb	VIIb	VIII	IIb	IIIa	IVa	Va	VIa	VIIa	0
LANTHANIDES														
	140.120 Cerium Ce 520.0 589.7 15 (20)	144.240 Neodymium Nd 485.1 482.5 490.2 15 (25)	145 Promethium Pm	150.400 Samarium Sm 439.5 476.0 15 (25)	151.960 Europium Eu 469.4 333.4 12 (20)	157.250 Gadolinium Gd 388.4 409.1 15 (25)	158.925 Terbium Tb 422.7 431.9 15 (25)	162.500 Dysprosium Dy 421.2 416.8 15 (25)	164.930 Holmium Ho 400.4 407.3 15 (25)	168.934 Thulium Tm 371.8 376.2 15 (25)	173.040 Ytterbium Yb 388.8 284.4 15 (25)	174.967 Lutetium Lu 336.0 337.7 8 (20)		
ACTINIDES														
	232.038 Thorium Th - 15 (25)	238.029 Uranium U 388.5 381.5 15 (25)	244 Plutonium Pu	243 Americium Am	247 Curium Cm	247 Berkelium Bk	251 Californium Cf	254 Einsteinium Es	257 Fermium Fm	258 Mendelevium Md	259 Nobelium No	260 Lawrencium Lr		